

European Communications in Mathematical and  
Theoretical Biology 2014, No. 17

# Communications

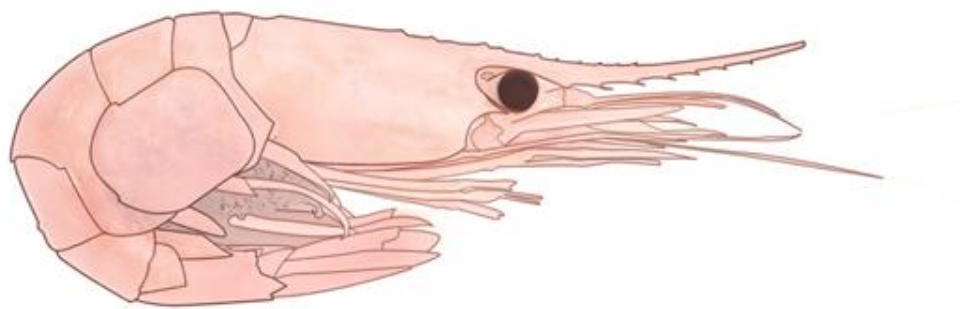

# ECMTB

9th European conference  
on mathematical and theoretical biology.



**A European Forum for Information,  
Presentation and Exchange**  
Official Communication Bulletin of ESMTB

**ECMTB Editorial Board**

**Barbara Boldin  
Andreas Deutsch  
Roeland Merks  
Andrea Pugliese  
Vitaly Volpert**

## Letter from the President

Dear Colleagues and Members,

In a few days the **9<sup>th</sup> Conference of the European Society for Mathematical and Theoretical Biology** will take place in Gothenburg. Like the previous ones, this Conference will host a huge number of presentations (the schedule includes 42 mini-symposia and other 271 contributed talks) on a very wide array of topics, ranging from microbial communities to blood flow, from the dynamics of viral hepatitis to virtual-tissue simulations. What all presentations will have in common is the development of a theoretical approach and of mathematical tools to analyse relevant problems in biology and medicine, as is the Society's aim. The Conference will definitely give a wide overview of research in the area in European countries, but also in many other parts of the world.

As an appetizer, this issue contains an extended abstract of the thesis by Andreas Raue winner of the **Reinhart Heinrich Doctoral Thesis Award 2013**, as well as two contributions describing new research activities. I hope you will find interesting reading this issue.

An important event that will take place during the Conference is the General Assembly, where all members can discuss in person about the state of the Society and future directions. In the Assembly, new candidates for the Society Board will be presented to prepare for the elections that will take place (on the Web site) later this year. As you may remember, 5 of the 10 Board members (including me) will end their mandate this year, and will have to be substituted by 5 new members; this is a very important stage in the Society, ensuring that everybody feels involved in the Society functioning, and that new energies get into the Society and make it reach new directions. We current Board members have contacted some potential candidates, but we encourage you all to make other suggestions.

I believe that there is ample room for the Society to increase its role in academic and scientific policies, and to help the visibility of researchers in mathematical biology. We collaborate on these issues with many other societies, from the "sister" Society on Mathematical Biology, to the "umbrellas" European Mathematical Society and International Council for Industrial and Applied Mathematics, but much more remains to be done.

The other main event organized by the Society for this year is the 5<sup>th</sup> edition of the **ESMTB-EMS Summer School**, that will be held as part of The Helsinki Summer School on Mathematical Ecology and Evolution from August 17 to 24 focussing on the Dynamics of Infectious Diseases.

The Society supports also other events going on this year, e.g. the International Conference MPDE'14 "Models in Population Dynamics and Ecology" at Turin on August 25<sup>th</sup>-29<sup>th</sup>, and the CIME-CIRM Course "Mathematical Models and Methods for Living Systems" at Levico, Italy, on September 1 - September 6. Limited travel funds for young scientists are also available.

As this is my last presidential address, I wish to thank you all for support, and especially those that have contributed more to society activities. In this respect, I think we should all deeply thank Andreas Deutsch who has served as Society's Treasurer for the past 12 years, and is now definitely ending his mandate. His activities both as Treasurer and responsible for the web site have given a great contribution to keeping the Society alive and in shape.

I conclude by reminding you of the next Conference that will take place, jointly with SMB, already in 2 years in 2016 in Nottingham, and by inviting you to renew the membership, if you forgot to do so (you can check your payments at the web site [www.esmtb.org](http://www.esmtb.org) ).

# Minutes of the ESMTB Board meeting

*Koper, Slovenia  
30<sup>th</sup> November 2013*

Meeting starts at 9.40

Present: Barbara Boldin (BB, Minutes), Reinhard Bürger (RB), Andreas Deutsch (AD), Peter Jagers (PJ), Andrea Pugliese (AP, Chair), Ryszard Rudnicki (RR), Vitaly Volpert (VV)

Absent: Miguel Herrero, Daphne Manoussaki, Roeland Merks

## 1. ECMTB 2014

PJ gives an update on ECMTB 2014:

- The list of plenary speakers is finalized and the conference poster is being sent to all Society members. Information should also be sent to SMB Newsletter. RB offers to help promoting the conference in the evolutionary biology community.
- The conference website <http://ecmtb2014.org/> is operational. Online registration is open, the website contains information about the fees for different categories (regular, student and ESMTB/SMB members). Since student ESMTB members can apply for a travel grant from ESMTB, AD suggests to add a link to ESMTB website. RR adds that an online convertor between SEK and EUR would be welcome.
- Online abstract submission is open, so is a call for mini-symposia proposals. Up until the end of November, eight suggestions for mini-symposia were submitted. The deadline for mini-symposia proposals is extended to 1<sup>st</sup> January, 2014. To encourage more proposals, e-mail reminders should be sent to current and previous Society members. The conference website is reviewed by Board members and some time is spent on discussing the form of mini-symposia sessions and abstract classification during submission. AD suggests that synchronisation of mini-symposia would be welcome and that speakers, as well as mini-symposia chairs, might welcome a sound signal to keep the talks within time limits.
- The poster session should be announced at the beginning of the conference. A deal is in preparation with Springer to offer an award for the best poster presented during ECMTB 2014, as well as for the best talk of the conference.
- The social programme of the conference includes a conference dinner, an excursion and a welcome reception by the city of Gothenburg. The conference website provides suggestions of several hotels in Gothenburg. AP suggests to add a link to hotel websites.
- Springer has offered to publish conference proceedings. The idea of publishing the proceedings is discussed, no final decision is made. The conference may also provide ideas for a special issue of JMB.
- A part of the conference is devoted to plenary lectures in connection with the Reinhart Heinrich award. AD informs the Board that two Reinhart Heinrich award winners will present their theses during ECMTB 2014 and a time slot to include these two lectures should be scheduled.
- AD suggests a book stand for Springer to promote JMB and ESMTB during ECMTB 2014.
- A time slot for the General Assembly of ESMTB should be scheduled.

## 2. ECMTB 2016

Markus Owen has kindly volunteered to organize ECMTB 2016 at the University Park Campus in Nottingham, UK. The time slot has not been fixed yet, it is suggested that the conference takes place in the first half of July. Preliminary ideas for a scientific committee are discussed. Since the 2016 conference will be a joint conference with SMB, the scientific committee needs approval from both societies. Board members agree that the final decision regarding the venue, lecture rooms and the conference dinner should be made before ECMTB 2014.

For the first time in ECMTB history, the conference will take place only two years after the previous event. The Board members discuss whether ECMTB will thereafter adopt a two year gap, or return to triennial events. No final decision is made.

### **3. Report of the treasurer**

AD hands out printed reports on ESMTB financial and membership data.

- *Membership development:* data on ESMTB membership in the years 2003-2013 is presented. The number of memberships peaked in 2005 (in the year of ECMTB 2005 in Dresden). Despite the ECMTB in Krakow, the number of memberships decreased in 2011, the numbers are even lower in 2012 and 2013. Up until November, ESMTB had 123 paying members in 2013. Some more payments are expected until the end of 2013. Payment reminders will be sent out. AD adds that a positive effect on ESMTB memberships is observed from flyer distribution. The next reminder will be sent out in January 2014, to allow new members time to register to ECMTB 2014 and to submit an abstract for the conference. AD presents 2013 membership data categorized by members' country of affiliation, membership type and payment categories. Membership fees remain the same as in the previous year and can be paid by bank draft transfer or by PayPal.
- *ESMTB support of schools/workshops:* in 2013, four requests for funding were received. The request to support MPDE in Osnabrück in August 2013 was later withdrawn. Three workshops (Mathways into cancer, Carmona, May 2013; Forum Biomath, Sofia, June 2013; Fourth Conference on Computational and Mathematical Population Dynamics, Taiyuan, May 2013) were financially supported by ESMTB, each with a contribution of 1000 euro.
- *ESMTB travel support:* in 2013, three requests were received for a travel support (one from France, India and Russia). All three applicants were granted the support of 500 euro each. More requests are expected in 2014, due to ECMTB in Gothenburg.
- *ESMTB account & audits:* AD presents current account data. Until the end of the year it is expected that around 1000 euro will be spent for printing and distribution of ESMTB Communications. AD informs the Board that two auditors will review the Society's financial data of the past two years by the Gothenburg conference in June 2014.

The end of AD's term as the Society's treasurer is approaching fast. AD suggests a name for his successor: a serious candidate, who is willing to take over as Society's treasurer. The candidate will present himself to the Board during the General Assembly in Gothenburg.

### **4. Communication/Information/Promotion**

In addition to taking care of Society's finances, AD has also been responsible for Society's website and ESMTB Infoletter. The end of AD's term therefore calls for another Board member to step in and take over these responsibilities. AD and BB agree to arrange a smooth transition of these duties to BB.

### **5. Board elections**

At the end of 2014, five members will end their term on the Board of ESMTB. These are: Andreas Deutsch, Miguel Herrero, Peter Jagers, Daphne Manoussaki and Andrea Pugliese. It is therefore time to start preparations for new Board elections. The Board proposes a preliminary list of potential candidates and agrees to finalize the list via e-mail exchanges by January and to send out invitations. The candidates for the following Board elections will be invited to the General Assembly of ESMTB in Gothenburg, where they will have a chance to present themselves and their plans on how to contribute to the Society.

### **6. Reinhart Heinrich award**

The Reinhart Heinrich award annually honors the best PhD thesis in the field of mathematical and theoretical biology. The awarding committee currently consists of Nico Beerenwinkel, Carlos Braumman, Andreas Deutsch, Philip Maini and Stefan Schuster. AD reports that six applications were received by the committee in 2012. The awarding committee nominated as winner of the Reinhart Heinrich Doctoral Thesis Award 2012 *Christoforos C. Hadjichrysanthou*. A summary of the award winning thesis will be published as the lead article in the 2013 issue of the European Communications in Mathematical and Theoretical Biology.

## 7. JMB Perspectives

The *Perspectives* series are published in JMB in the form of short articles, aiming to express topical issues in mathematical and theoretical biology. Helen Byrne and Roeland Merks are in charge of the Perspectives series. In the absence of RM, and with no update received from Helen Byrne, the Board is unable to assess the current state of affairs with the series. AP is aware of one article submitted for the Perspectives series and one other article in preparation.

It is observed that Perspectives articles are not easily found on JMB website. AD suggests to contact the Springer representative Eva Hiripi for help in making the Perspectives series more visible. In addition, the ESMTB website needs an update to include all Perspectives articles published up to date.

## 8. Communications of ESMTB

VV describes preparations of the recent issue of Communications. The 2013 issue of Communications is ready and will be sent for printing early in December.

## 9. Summer schools

The 2014 EMS-ESMTB will take place between the 17<sup>th</sup> and 24<sup>th</sup> of August 2014 at the Linnasmäki Congress Centre in Turku, Finland. The focus of the school will be the *Dynamics of infectious diseases*. Lecturers are:

- Odo Diekmann (University of Utrecht): Population dynamics of infectious diseases
- Frank Ball (University of Nottingham): Stochastic models of epidemics
- Thomas House (University of Warwick): Networks and epidemics
- Michel Langlais (University of Bordeaux): Spatial dynamics of infectious diseases
- Troy Day (Queen's University): Evolution of hosts and pathogens

More information about the 2014 EMS-ESMTB school can be found on the school website <http://mathstat.helsinki.fi/research/biomath/summerschool2014/>

RR volunteers to explore the possibilities for organising the 2015 EMS-ESMTB school in Bedlewo, Poland. Some initial ideas for school topics are discussed and Board members agree to finalize the decision via e-mail before ECMTB 2014 in Gothenburg.

The meeting ends at 15.50

*Barbara Boldin*  
*Secretary of ESMTB*

## Extended abstract of the awarded thesis

### Quantitative Dynamic Modeling: Theory and Application to Signal Transduction in the Erythropoietic System

*Doctoral Thesis by Andreas Raue*

*Supervisor: Professor Jens Timmer*

The contents of this thesis summary are based on Raue et al. (2010), Raue et al. (2011), Raue et al. (2013) and Raue et al. (2014). In this thesis quantitative dynamic models are used to study these mechanisms, i.e. the dynamics of molecular compounds and their physical interactions, giving rise to emergent properties of biochemical processes inside the cell. However, the increasing size and complexity of both models and experimental data require efficient and reliable computational methods for model construction, calibration and uncertainty analysis of model predictions. Therefore, a detailed discussion and comparison of methods used for quantitative dynamic modeling is presented. The results suggest best practices for quantitative dynamic modeling and are summarized in a comprehensive protocol (Figure 1) that is complemented by source code (<https://bitbucket.org/d2d-development/d2d-software/wiki/Home>).

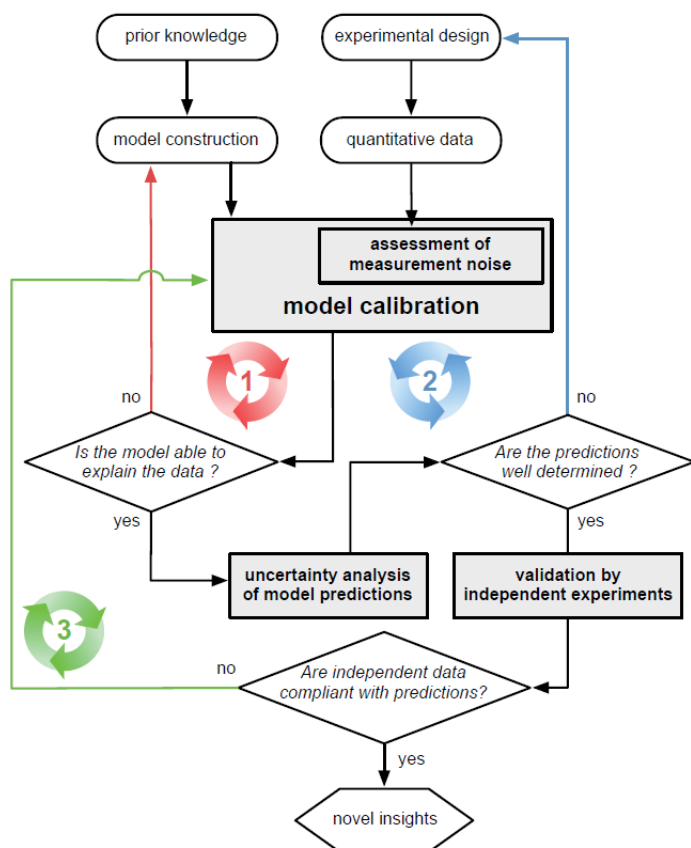

Figure 1: Guide to quantitative dynamic modeling. A first candidate model is constructed based on prior knowledge. The model is calibrated using quantitative data based on specifically designed experiments. In a first iterative cycle (red) the model is refined until its output is sufficiently in agreement with the available data. In a second iterative cycle (blue) it is investigated if the desired predictions are sufficiently determined. If they are not sufficiently determined, for example because a part of the model necessary for the predictions has not been sufficiently covered by experiments, additional experiments have to be designed to improve the predictive power. In a third iterative cycle (green) the model predictions are validated using independent experiments. Finally, the model and its predictions can be analyzed to obtain novel insights into the dynamics of the system.

The protocol is applied to two quantitative dynamic models of signal transduction in the erythropoietic system. Erythropoiesis is the production of erythrocytes, red blood cells. The first model describes the complex interactions between the hormone erythropoietin (Epo) and its

membrane receptor (Figure 2a; Becker *et al.* (2010)). The second model describes Epo induced JAK2/STAT5 signal transduction (Figure 2; Bachmann *et al.* (2011)). Phosphorylated STAT5 is a transcription factor that translocates into the cell nucleus and leads to the survival of erythroid progenitor cells. Both models yield insights into key properties of the dynamics of signal transduction in the erythropoietic system that, in combination, become important in a clinical setting.

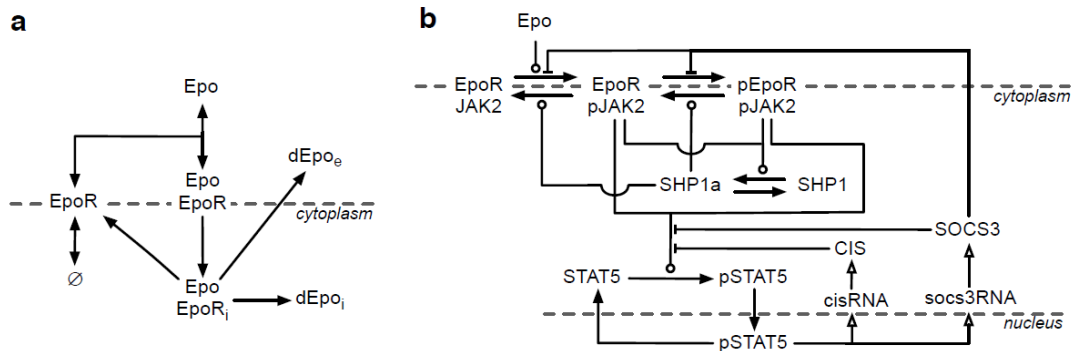

Figure 2: Quantitative dynamic models describing erythropoietin (Epo) signaling. (a) Epo receptor model. The model describes the interaction and the trafficking of Epo and of its membrane receptor (EpoR). The active complex Epo\_EpoR can be internalized (Epo\_EpoR<sub>i</sub>) and is either recycled back to the cell membrane or degraded (dEpo<sub>i</sub>, dEpo<sub>e</sub>). (b) Model of Epo induced JAK2/STAT5 signaling. Epo induces transphosphorylation of JAK2 (pJAK2) and pJAK2 in turn phosphorylates EpoR (pEpoR). Subsequently, STAT5 is phosphorylated (pSTAT5) by both EpoR\_pJAK2 and pEpoR\_pJAK2 and shuttles to the nucleus where it induces target gene expression. Two of the target genes encode for the negative feedback regulators suppressor of cytokine signaling 3 (socs3RNA, SOCS3) and cytokine-inducible SH2-containing protein (cisRNA, CIS). Moreover, the protein tyrosine phosphatase SHP1 is activated (SHP1a) by pEpoR\_pJAK2 and lead to dephosphorylation of the receptor complex.

On the theoretical side, an approach that simultaneously calibrates the model parameters that determine the model dynamics and characterizes the measurement noise is proposed and compared to the standard approach. For model calibration, i.e. the estimation of unknown model parameters, the performance of multiple stochastic, deterministic and hybrid optimization algorithms are compared (Figure 3). These results show that the most accurate and efficient method is deterministic derivative-based optimization using the sensitivity equations for the calculation of derivatives in combination with a multi-start strategy based on Latin hypercube sampling of the initial guesses for the parameters.

An alternative parameterization of the dynamics that exploits scaling invariances can further increase the performance of parameter estimation for larger applications. The alternative parameterization also facilitates a direct resolution of ambiguities in the parameterization of the dynamics that can lead to non-identifiability in the case of relative data. Non-identifiability indicates that model parameters cannot be determined from experimental data. Non-identifiability often induces non-observability of the dynamics. Using the profile likelihood approach two general strategies that resolve both non-identifiability and non-observability can be pursued: the design of new experiments and simplification of the model. Finally, for the quantification of uncertainty in model parameters and predictions, the results of the profile likelihood approach and of Markov-chain Monte Carlo sampling are compared employing both the Epo receptor model and the JAK2/STAT5 model. Interestingly, for the Epo receptor model, it is shown that the result of Markov-chain Monte Carlo sampling is misleading in the presence of non-identifiability (Figure 4).

On the applied side, the Epo receptor model and JAK2/STAT5 model are introduced. The iterative cycle between experimentation, modeling and experimental design is elucidated in detail for



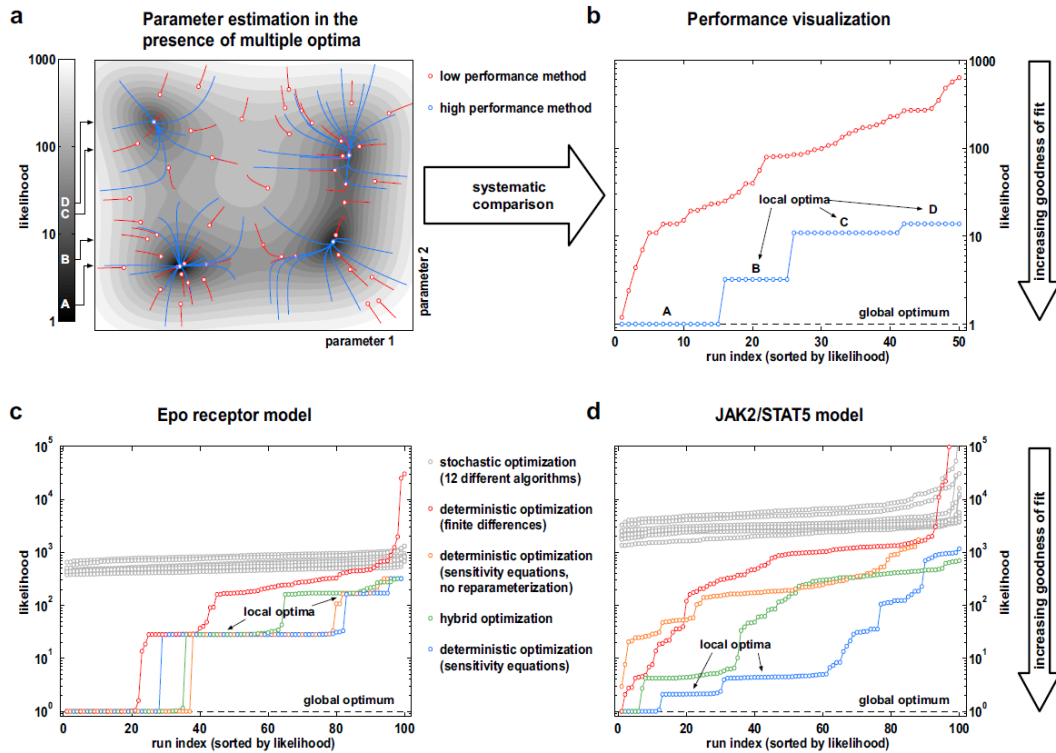

Figure 3: Performance analysis of parameter estimation using numerical optimization methods. (a) A two dimensional parameter estimation problem bearing multiple optima (global: A; local: B,C,D) is displayed for illustrative purposes. In the left panel, the traces in parameter space of two hypothetical methods with high (blue) and low performance (red) are displayed. 50 independent runs with each method are displayed; the circles indicate the results of the estimation. In real applications with high dimensional parameter spaces this visualization is not possible. However, the likelihood values corresponding to the estimation results can be compared systematically. (b) The visualization of optimization performance by sorting likelihood values increasingly is also possible for high dimensional problems. It reveals that the performance of the red method is low, i.e. results are unreliable, whereas the performance of the blue method is high, i.e. results are reproducible and reliable. (c,d) Visualization of performance using 100 independent optimization runs with each of the considered algorithms for both models. For illustrative reasons, the global optimum was centered to one. For stochastic optimization (gray), 12 different algorithms were used. For deterministic optimization, two different approaches for the calculation of derivatives were compared: (i) finite difference approximation (red) and (ii) analytically derived sensitivity equations (orange and blue). Initial guesses for the parameters were generated by Latin hypercube sampling.

the construction and calibration of the Epo receptor model. Following the best practice protocol reliable predictions for both models can be obtained that lead to novel insights into the dynamics of the erythropoietic systems. The Epo receptor model explains how erythroid progenitor cells are able to interpret hormone concentration that can vary up to 1000-fold *in vivo* (Figure 5a,c). The JAK2/STAT5 model dissects the roles of two transcriptional negative feedback regulators that facilitate to control the signal over a broad range of hormone concentration that is forwarded from the Epo receptor level (Figure 5b). Finally, a quantitative link from hormone concentration via phosphorylated STAT5 in nucleus to the survival rate of erythroid progenitor cells could be established (Figure 5d).

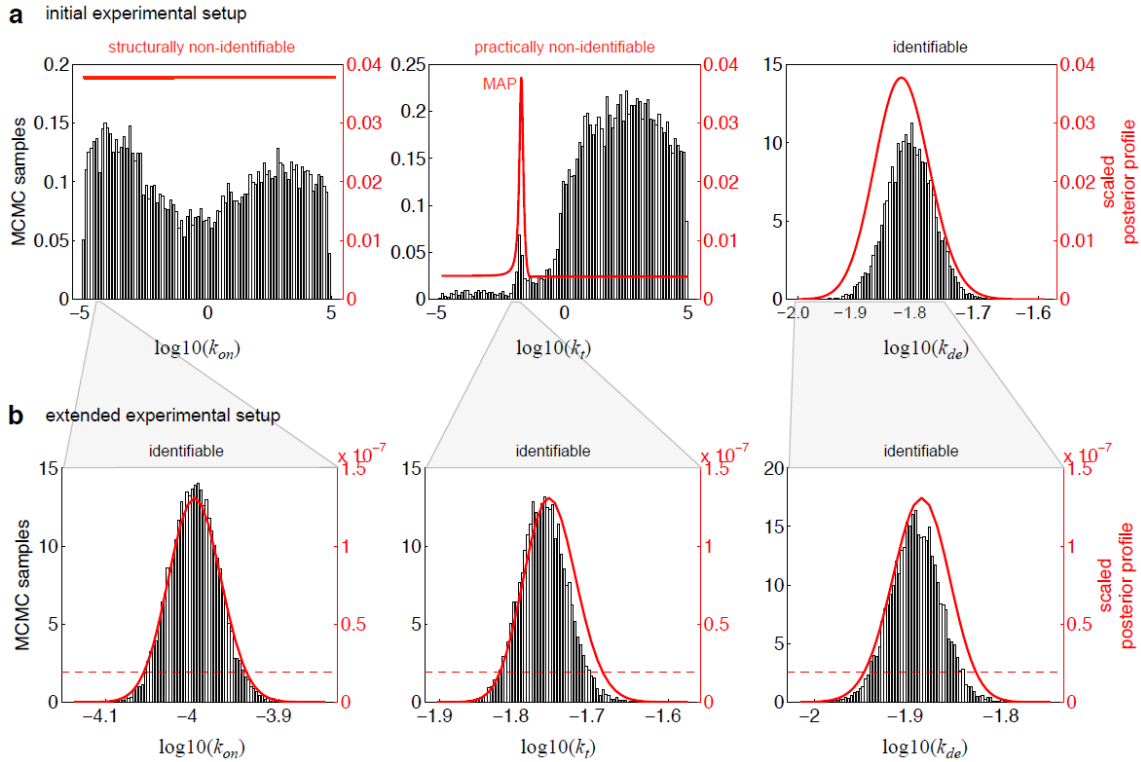

Figure 4: Comparison of profile posterior approach (red) and MCMC sampling for the Epo receptor model. (a) For the initial experimental setup the posterior profiles (red) indicated that parameter  $k_{on}$  is structurally non-identifiable, parameter  $k_t$  is practically non-identifiable and parameter  $k_{de}$  is identifiable. The histograms display the marginalized MCMC samples obtained by the MMALA algorithm. For the identifiable parameter  $k_{de}$  both results of profiling and sampling agree quite well. Also for the structurally non-identifiable parameter  $k_{on}$  the agreement is acceptable. For the practically non-identifiable parameter  $k_t$  the results are substantially different. The profile shows that the MAP point is located at  $\log_{10}(k_t) \approx 1.8$ . However, the lion's share of the marginalized MCMC samples propose  $\log_{10}(k_t)$  to be  $> 0$ . (b) Taking into account more experimental data the posterior profiles for the extended experimental setup indicate that all parameters are now identifiable. The results of MCMC sampling and profiling are in good agreement. Interestingly, the MCMC samples for parameter  $k_t$  for the extended setup are localized close to the MAP point of the initial setup, note the different scales on the x-axis for (a) and (b). The dashed red lines indicate the threshold that can be used to assess confidence intervals.

## Summary and Outlook

In this thesis a comprehensive discussion and comparison of methods used for quantitative dynamic modeling was presented. Two models from signaling in the erythropoietic system, the Epo receptor model and the JAK2/STAT5 model, were developed and have been used as benchmark applications for the method comparison. The results are summarized in a best practice protocol that provides practical guidance for future applications. Model calibration and experimental design are the key steps in the quantitative dynamic modeling approach. The best practice protocol proposed here was awarded as best performing procedure in the Dialogue for Reverse Engineering and Methods (DREAM) in 2011, 2012 and 2013.

The results that have been obtained for the erythropoietic system become clinically relevant in the context of cancer treatment. Traditional chemotherapy treatment kills cells that divide rapidly, such as cancer cells. However, also non-malignant cells that divide rapidly such as cells in the bone marrow, digestive tract, and hair follicles are affected. Therefore, a side effect of chemotherapy can be anemia, the lack of erythrocytes in the body that can be a serious threat for the health of patients. To counteract cancer induced anemia Epo can be administrated to enhance the production of additional erythrocytes. However, in the context of lung cancer adverse effects of Epo treatment were observed

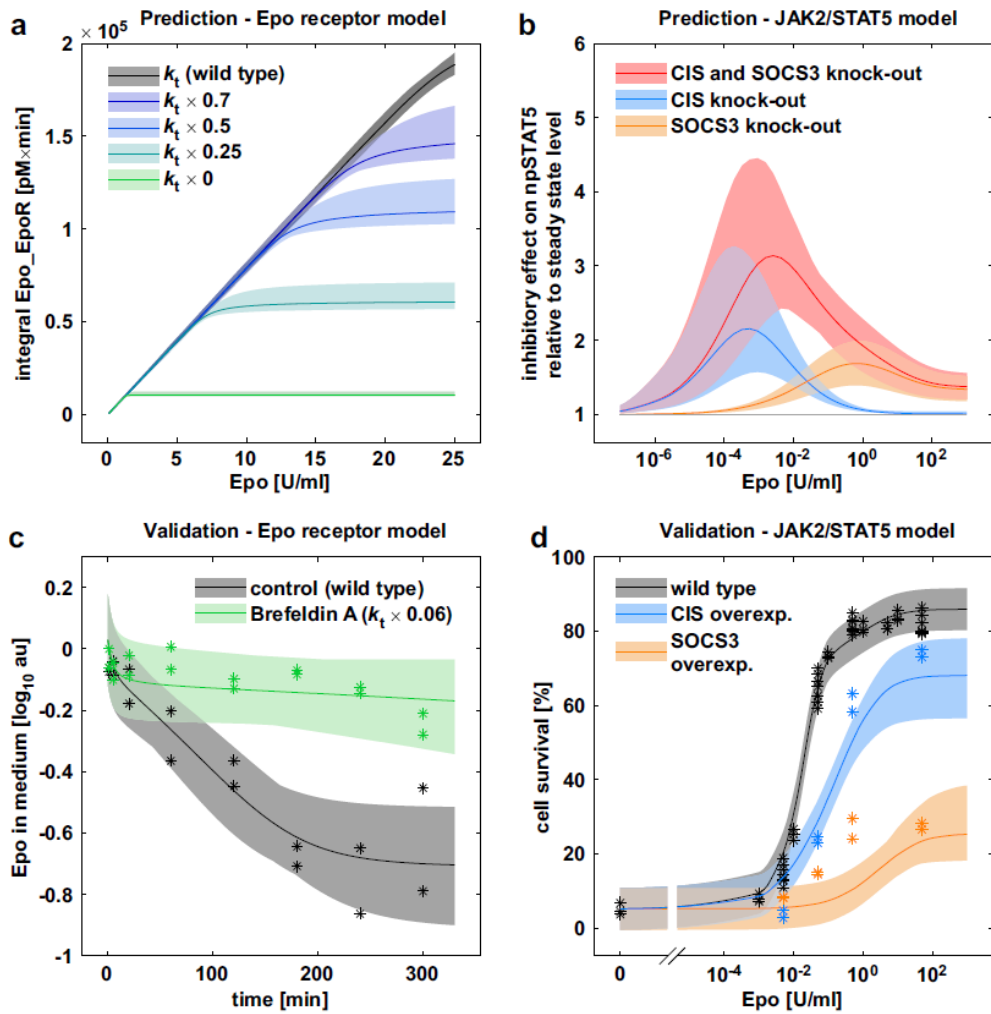

Figure 5: Model predictions (a,b) that lead to novel insights into the biological systems and their independent experimental validation (c,d). Predictions for optimal parameter values are indicated by solid lines, the prediction uncertainty in terms of 95% confidence bands is indicated by shading. Independent validation data are displayed by asterisks. (a) Predicted Epo dose-dependency of occupied receptor complex (Epo\_EpoR) integrated over 18 hours for decreasing values of the receptor turnover rate  $k_t$ . (b) Predicted effect of CIS and SOCS3 single and double knock-out on the nuclear phosphorylated STAT5 (npSTAT5) steady state level for various doses of Epo. (c) Experimental validation for predictions shown in (a) using independent data from cells treated with Brefeldin A that reduces receptor turnover. (d) Experimental validation for predictions shown in (b) using independent data from cell survival studies for wild type and overexpression conditions. For predicting the cell survival rate the integrated response of npSTAT5 over 60 minutes was used.

such as decreased survival prognosis for patients. This effect could be explained by the observation that certain lung cancer cell lines express the Epo receptor. Epo triggers survival signals for CFU-E cells. Likewise stimulation with Epo could be associated with a protection of cancer cells against chemotherapy treatment. Preliminary experimental results support this hypothesis. In analogy to the JAK2/STAT5 model for CFU-E cells presented here, we constructed a JAK2/STAT5 signaling model for a lung cancer cell lines. Comparison of the response properties of both models showed that the lung cancer cells potentially need higher doses of Epo to react in a comparable manner like CFU-E cells. This would suggest a safe range of Epo dose that allows stimulating the survival of CFU-E cells but would not lead to increase cancer progression. Experimental validation of this hypothesis is currently ongoing.

## Acknowledgements

I greatly thank my supervisor Prof. Jens Timmer for his excellent support, scientific education, and for the outstanding academic freedom. I am very thankful to Prof. Dr. Fabian Theis who introduced me into Bayesian statistics and let me stay as a long-term guest in his group, to Prof. Dr. Ursula Klingmüller for outstanding collaboration and for introducing me into cell biology, and to Prof. Dr. med. Johannes Bode for ongoing and fruitful collaboration that are not presented in this thesis. My sincerest thanks and appreciation goes to the awarding committee for awarding my thesis the Reinhart Heinrich Doctoral Thesis Award 2012. I would also like to extend my thanks to ESMTB for giving me the opportunity to present my thesis here.

## References

- Raue A, Becker V, Klingmüller U, and Timmer J. Identifiability and observability analysis for experimental design in non-linear dynamical models. *Chaos* 20(4), 045105, 2010.
- Raue A, Kreutz C, Maiwald T, Klingmüller U, and Timmer J. Addressing parameter identifiability by model-based experimentation. *IET Systems Biology* 5(2), 120–130, 2011.
- Raue A, Kreutz C, Theis F, and Timmer J. Joining forces of Bayesian and frequentist methodology: A study for inference in the presence of non-identifiability. *Phil. Trans. Roy. Soc. A* 371, 20110544, 2013.
- Raue A, Schilling M, Bachmann J, Matteson A, Schelker M, Kaschek D, Hug S, Kreutz C, Harms B, Theis F, Klingmüller U, and Timmer J. Lessons learned from quantitative dynamic modeling in systems biology. *PLOS ONE* 8(9), e74335, 2014.
- Becker V, Schilling M, Bachmann J, Baumann U, Raue A, Maiwald T, Timmer J, and Klingmueller U. Covering a broad dynamic range: information processing at the erythropoietin receptor. *Science* 328(5984), 1404–1408, 2010.
- Bachmann J, Raue A, Schilling M, Böhm M, Kreutz C, Kaschek D, Busch H, Gretz N, Lehmann W, Timmer J, and Klingmüller U. Division of labor by dual feedback regulators controls JAK2/STAT5 signaling over broad ligand range. *Molecular Systems Biology* 7, 516, 2011.

# Topics in Mathematical Biology

## Dynamical systems in drug development

Lambertus A. Peletier (1) and Johan Gabrielsson (2)

1 Mathematical Institute, Leiden University, PB 9512, 2300 RA Leiden, The Netherlands;  
peletier@math.leidenuniv.nl

2 Swedish University of Agricultural Sciences, Department of Biomedical Sciences and  
Veterinary Public Health, Division of Pharmacology and Toxicology, Box 7028, SE-750 07  
Uppsala, Sweden; johan.gabrielsson@slu.se

The increased speed of the drug-development process, generation of data and the rebirth of quantitative pharmacology calls for new tools and approaches, over and above the traditional exponential models and goodness of fit statistics. A mathematical/analytical approach then becomes a prerequisite to cast light on complex dynamics hidden in concentration-time, response-time and concentration-response profiles.

In recent years the applications of mathematics in drug development has gained momentum. Even the FDA is considering approval of compounds in part on the basis of arguments based on modeling and simulation (cf. [1]). But there is a great variety of ways in which mathematical methods can play a role in drug discovery and development.

On the one hand, the industrial scientist is often faced with the problem to make reliable predictions about such issues as optimal dose or assessment of safety, on the basis of data about *onset*, *intensity* and *duration* of response, when quantitative information about the underlying physiology is limited. The challenge is then to combine available physiological knowledge, well designed experiments and mathematical analysis to develop a model which can be used to make such reliable predictions.

On the other hand, with expanding knowledge about biological and physiological processes, more systems-based studies are being carried out in which mathematical ideas about dynamical systems are used, for instance, to model complex regulatory networks (cf. [2], [3]).

In this note we present two case studies where physiological information is limited. They demonstrate how information about magnitude and duration of drug impact can be extracted from response-time data sets when utilising a mix of physiological information and dynamical systems theory.

The two case studies differ in that in the first study, information is available about the drug concentration in the blood plasma. In many cases it can be measured separately. Here the question centres on how this concentration versus time profile results in the corresponding response of the system (*Pharmacodynamics*). In the second case study the distribution of the drug in the body is not known. This situation arises when drug is administered locally, e.g., into the eye or through inhaling.

**Case Study 1:** This case study is based on a study of Siemers et al. [4] on the impact of a  $\gamma$ -secretase inhibitor on the plasma concentration of *Amyloid beta* ( $A\beta_{1-40}$ ), the inhibitor being supplied orally in three doses: 60, 100 and 140 mg. Plasma concentration profiles demonstrate simple first-order drug elimination. However, it leads to complex and counter-intuitive response versus time

curves.

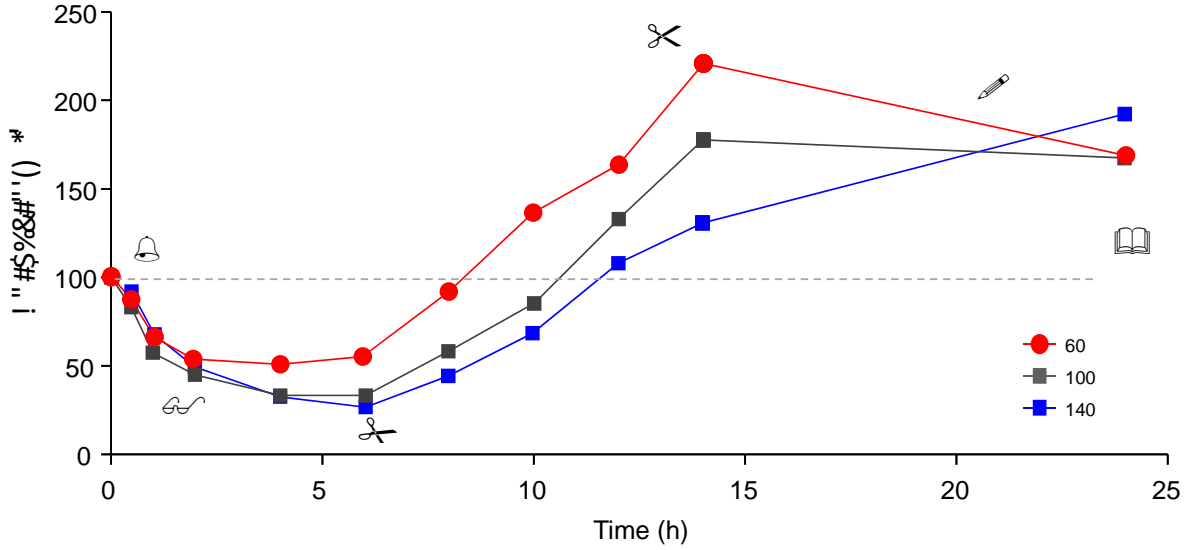

**Figure 1** Response versus time graph of *Amyloid beta*  $A\beta_{1-40}$  after acute dosing of 60 (red), 100 (grey) and 140 mg (blue) of a  $\gamma$ -secretase inhibitor [4]. The numbers in circles refer to baseline (1), initial inhibitory action (2), duration of the inhibitory action (3), rebound (4) and (5) and return to the pre-dose baseline value (6).

The data, shown in Figure 1, exhibit several surprising features: (i) The impact of the  $\gamma$ -secretase inhibitor shifts from initial inhibition to eventual stimulation. (ii) The point where one goes over into the other, i.e., the time at which the response curve crosses the baseline (Response = 100%) shifts *sub-linearly* to the right, and (iii) As the drug dose increases, the rebound, if anything, decreases. This latter property is contrary to what one normally expects from systems involving feedback.

The drug being a  $\gamma$ -secretase inhibitor, the stimulatory effect comes as a surprise. Evidently the drug has two, opposing, effects, the inhibiting one dominating initially, and the stimulating one at later times. Since the plasma concentration decreases with time, inhibition appears to be associated with high concentration and stimulation with low concentration.

It turns out that, within the framework of indirect response models, or *Turnover models* (cf. [5]), such dynamics can be reasonably well described mathematically by:

$$\frac{dR}{dt} = k_{in}I(C) \cdot S(C) - k_{out}R$$

where  $I(C)$  and  $S(C)$  model, respectively, the inhibitory and the stimulatory impact of the drug - at concentration  $C$  - on the dynamics of the response  $R$ . Typical examples of such functions are

$$I(C) = 1 - I_{max} \frac{C^n}{IC_{50}^n + C^n}$$

$$S(C) = 1 + S_{max} \frac{C^n}{SC_{50}^n + C^n}$$

where  $IC_{50}$  and  $SC_{50}$  are referred to as the *potencies* of the drug,  $I_{max}$  and  $S_{max}$  are maximal extent of their impact, and  $n$  the Hill exponent. Here,  $k_{in}$  and  $k_{out}$  are, respectively a zero- and a first order rate constant. Since inhibition dominates stimulation at high values of  $C$ , and stimulation dominates at low values of  $C$ , we must conclude that  $IC_{50} > SC_{50}$ . In fact, careful study of the data yields estimates for the two potencies.

Alternative turnover models are also possible: inhibition affecting  $k_{in}$  as well as  $k_{out}$ , or

stimulation affecting both terms, or inhibition and stimulation both affecting  $k_{out}$ , in each case adjusting the potencies appropriately. Utilising what is known about the physiology, together with information from the data and the dynamics of the four different systems (cf. [6]) may point to which of these models fits the data best for different drug doses.

**Case Study 2:** This case study is concerned with the release of acetylcholine (ACh) caused by three single subcutaneous administrations (20, 40 and 80  $\mu\text{mol} \cdot \text{kg}^{-1}$ ) of TC-1734, an active neuronal nicotinic ACh receptor modulator which enhances the release of ACh into the cerebral cortex of rats. It has been shown to exhibit memory enhancing properties in rats and mice (cf. Gatto et al., [7]).

In Figure 2 we show the increase of the ACh release as it evolves over time caused by the three doses of TC-1734 to rats.

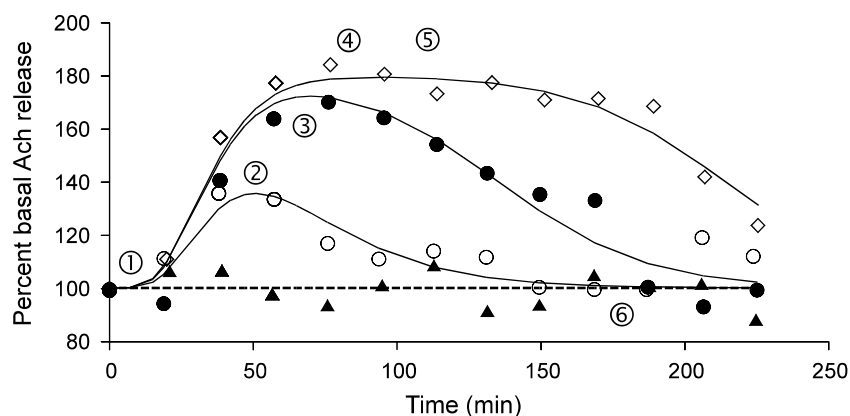

**Figure 2** Per cent basal release (%) of ACh-versus-time data following three subcutaneous 20, 40 and 80  $\mu\text{mol} \cdot \text{kg}^{-1}$  doses of TC-1734 to rats [7]. Data are normalized to 100 % at baseline. The initial rise in response is slightly delayed (1), and displays a peak-shift with increasing doses (2 - 4). The highest dose displays a very flat top which is an indication of saturation of response (5). The response then returns to the pre-dose baseline again (6).

Conspicuous features of the data are (i) an initial delay, (ii) a peak shift with increasing drug dose  $D$ , (iii) a shift of the elimination phase which seems proportional to  $\log(D)$ , and (iv) for the higher doses, saturation of the response.

In this case study, no pharmacokinetic information is available and the dynamics needs to be assessed purely on the basis of response versus time data for different drug doses and routes. The approach is often referred to as *Dose-Response-Time analysis* (DRT) and goes back to the late 1960's (cf. [8], [9]).

It is assumed that the drug enters a hypothetical *biophase*, where it follows its own kinetics and then drives the pharmacodynamic response. The objective is now to design *two* models: one for the biophase and one for the pharmacodynamic response, all on the basis of response-time graphs for different drug doses and drug routes.

A typical problem one encounters here is how to decide whether a particular feature of the response-time graph is due to properties of the biophase model or to the pharmacodynamic model. Thus, how does one decide whether saturation effects are due to nonlinearity in the biophase kinetics or in the pharmacology, or what determines the decay of response: elimination of drug from biophase or pharmacodynamic processes.

A detailed analysis of the data, exploiting the drug route, different drug doses, physiological information and mathematical properties of the models involved, suggests here a first order model for the drug in biophase (amount  $A_b$ ) which stimulates the production term  $k_{in}$  of a turnover model, which in turn is coupled to an array of transduction compartments, as shown in Figure 3 (cf. [10] for

more details).

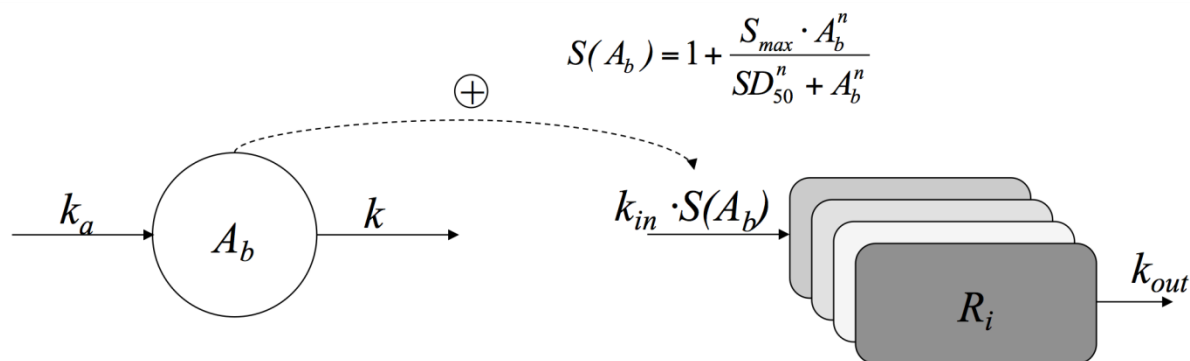

**Figure 3** A first order model for the amount of drug in biophase ( $A_b$ ), which stimulates the production term  $k_{in}$  of a turnover model through the function  $S(A_b)$ , coupled with a transduction pathway. In this model,  $k_a$ ,  $k$  and  $k_{out}$  are first order rate constants.

**Conclusion:** In this note we have focused on the environment many industrial scientists involved in *Modelling and Simulations* find themselves. The requirement to come up with a model which accurately predicts the impact of a drug on the basis of experimental data, whilst the physiological and biochemical knowledge of the processes involved in the route from drug input to pharmacological response are only partially known. In this *Data Driven*<sup>1</sup> endeavour, which has much in common with addressing an inverse problem, mathematical analysis can play a central role in teasing out the physiology hidden in the data.

## References

1. Woodcock, J., and Woosley, R. (2008). The FDA Critical Path Initiative and its influence on new drug development. *Annu. Rev. Med.* 59, 1–12.
2. Benson, N., Cucurull-Sanchez, L., Demin, O., Smirnov, S., and van der Graaf, P. (2012). Reducing systems biology to practice in pharmaceutical company research; selected case studies. *Adv. Syst. Biol.* 736, 607–615.
3. Fujioka, A., Terai, K., Itoh, R., Aoki, K., Nakamura, T., Kuroda, S., Nishida, E., and Matsuda, M. (2006). Dynamics of the Ras/ERK MAPK cascade as monitored by fluorescent probes. *J. Biol. Chem.* 281, 8917–8926.
4. Siemers, E., Dean, R., Friedrich, S., Ferguson-Sells, L., Gonzales, C., Farlow, M., and May, P. (2007). Safety, tolerability, and effects on plasma and cerebrospinal fluid Amyloid-b after inhibition of c-Secretase. *Clin. Neuropharmacol.* 30, 317–325.
5. Dayneka, N., Garg, V., and Jusko, W. (1993). Comparison of four basic models of indirect pharmacodynamic responses. *J. Pharmacokin. Biopharm.* 21, 457–478.
6. Krzyzanski, W., and Jusko, W. (1998). Mathematical formalism and characteristics of four basic models of indirect pharmacodynamic responses for drug infusions. *J. Pharmacokin. Biopharm.* 26, 385–408.
7. Gatto, G., Bohme, G., Caldwell, W., Letchworth, S., Traina, V., Obinu, M., Laville, M., Reibaud, M., Pradier, L., Dunbar, G., et al. (2004). TC-1734: An orally active neuronal nicotinic acetylcholine receptor modulator with antidepressant, neuroprotective and long-lasting cognitive effects. *CNS Drug Reviews* 10, 147–166.
8. Levy, G. (1966). Kinetics of pharmacological effects. *Clin. Pharmacol. Ther.* 7, 362.
9. Smolen, V. (1971). Quantitative determination of drug bioavailability and biokinetic behavior from pharmacological data for ophthalmic and oral administration of a mydriatic drug. *J. Pharm. Sci.* 60, 354–363.
10. Peletier, L., and Gabrielsson, J. (in press). Dose-response-time data analysis involving nonlinear dynamics, feedback and delay. *Eur. J. Pharm. Sci.* Available at: <http://dx.doi.org/10.1016/j.ejps.2014.04.007>.

<sup>1</sup>Douglas Lauffenburger recently used this term in the 7th Noordwijkerhout Symposium on Pharmacokinetics, Pharmacodynamics and Systems Pharmacology, 23-25 April 2014, Noordwijkerhout, The Netherlands.



# Discrete dynamics of contagious social diseases: example of obesity

J. Demongeot<sup>1</sup>, O. Hansen<sup>1</sup>, C. Taramasco<sup>2</sup>

<sup>1</sup> *University J. Fourier of Grenoble, Lab. AGIM, CNRS FRE 3405, Faculty of Medicine, 38700 La Tronche, France*

<sup>2</sup> *Escuela de Ingeniería Civil en Informática, Universidad de Valparaíso, Chile*

**Abstract:** Modelling contagious diseases needs to incorporate information about social networks through which the disease spreads out as well as data about demographic and genetic changes in the susceptible population. In this paper, we propose a theoretical framework (conceptualization and formalization) which seeks to model obesity as a process of transformation of one's own body determined by individual (physical and psychological), inter-individual (relational, *i.e.*, relative to the relationship between the individual and others) and socio-cultural (environmental, *i.e.*, relative to the relationship between the individual and his milieu) factors. Individual and inter-individual factors are tied to each other in a socio-cultural context whose impact is notably related to the visibility of any body being exposed on the public stage in a non-contingent way. The question we are dealing with in this article is whether such kind of social diseases, *i.e.*, depending upon socio-environmental exposure, can be considered as "contagious". In other words, can obesity be propagated from individuals to individuals or from environmental sources over a whole population?

**Keywords:** social networks; contagious social diseases; obesity; homophilic rule

## 1 Introduction

Social and socio-infectious diseases (like Sexually Transmitted Diseases, SMD's) are numerous and obesity can be considered as one of the most characteristic of what could be identified as a social "contagious" disease. Both stigmatization and mimicking [1] constitute the way of dissemination of obesity into a family or a social network. Obesity is defined as an abnormal or excessive accumulation of fat in adipose tissue (Body Mass Index or  $BMI \geq 30$ , where  $BMI = \text{Weight (kg)} / \text{Size}^2 \text{ (m}^2\text{)}$ ) leading to more or less important health problems at the individual level.

Currently, obesity would reach an pandemic development everywhere in the world: according to the latest world estimates of WHO (World Health Organization), obesity rate would have tripled between 1980 and 2005 [2,3]. This rate of development suggests that this pathology involves a socio-cultural problem grafted into a predisposition at the individual level. All specialists agree now that, for decades, we are witnessing an increase in worldwide obesity prevalence. This is true in developed as well as in developing countries. No society seems to be immunized against this pandemic. Data from MONICA (WHO) project [2] show that obesity prevalence in the majority of the European countries increased in 10 years (1992-2002), going from 10 to 20% in men and from 10 to 25% amongst women. In France, between 1980 and 2006, obesity prevalence went from 6.4% to 16% in men and from 6.3% to 17.6% amongst women [3,4]. Based on these facts, several studies have been performed to identify risk factors associated with this affection as well as to contain the pandemic, which became a real public health problem [5]. It is well known that obesity has a genetic component as a familiar predisposition towards this affection testifies. However, this genetic component does not explain the increasing (spectacular) progression in disease prevalence. Additional behavioral, psycho-social, and economic factors must be considered [6-8]. In this context, Christakis et al. showed the possibility of person to person obesity contagion in a social network [9]. Moreover, Cohen et al. suggested that obesity diffusion could occur via a common exogenous source applied to a set of individuals [10].

Realistic models of contagious diseases incorporate information about the social networks through which the disease spreads out as well as data about demographic and genetic changes in the susceptible population. They also include all the possible knowledge about the contacts between susceptible and sick individuals. In Section 2, we will present the mathematical framework necessary

to take into account at a microscopic level the dynamics of contacts between susceptible and sick individuals. Then we will introduce the description of the dynamics of obesity in Section 3, a social pathology partly caused by collective behaviours mimicking some dominant habits of nutrition transmitted through social networks. Obesity spread modelling will use the notion of homophilic graphs.

To investigate obesity in a multi-factorial manner, we take into account inseparable factors to analyze the impact through time that obese individual transformation may have on the social structure. With this aim, we develop a network model in which individual interactions are in part due to homophilic selection/deselection, *i.e.*, a process of preferential attachment and detachment of inter-individual links according to characteristics of the individuals involved. Homophily is here defined as the tendency of an individual to create links with other individuals sharing similar attributes with him and to cut links with other dissimilar individuals. Homophily suggests that individuals tend to interact with those who resemble them. Second, and reciprocally, we study if obesity can be considered as a “contagious” social disease. So we study the role which could be played by the structure of the social fabric in the increase and current development of obesity.

We evaluate the impact of relations between individuals (micro-level) as well as the impact of relations between districts (meso-level) and between countries (macro-level). This approach highlights the necessity to integrate the dynamics of each scale to better understand the evolution of the pathology. It is proposed two stochastic models: i) an epidemiological compartmental model and ii) an individual centered network model, considering three influences: exogenous heterogeneous (individual-cultural), exogenous homogeneous (individual-social) and endogenous (individual-individual). Altogether, this research study on obesity will allow to investigate the social and cultural dimension involved in being and transforming one’s body.

In Section 4, we present elements of demographic dynamics to add to the social contagion dynamics. Eventually, we present in Section 5 a proposal of an obesity preventive policy and in Section 6 we propose some perspectives about a new more realistic modelling of the contact dynamics.

## 2 Social networks and obesity

### 2.1. General graph framework

Given that each individual is immersed in a social system, linked together with other individuals through diverse and complex interactions, each individual  $i$  can then be characterized, in a first approach, by their number of neighbors  $k_i$ , whereas the overall system is characterized by the connection structure between individuals. To study the role played by social interactions in obesity spreading, five simple network topologies are considered to describe inter-individual connections: random (Erdős-Renyi type), scale-free, small-world and two empirical network topologies.

The empirical networks are built from degree distributions found for Christakis et al. [8] in real networks. On Figure 1, we can find examples of architecture simulated following the above topologies. We will use these architectures for starting from initial configurations of the *a priori* network, before applying the homophilic rule and converging to an “attractor” of its dynamics, *i.e.*, a stable configuration of links and node states of the interaction graph related to the social network involved in contagion of the obesity.

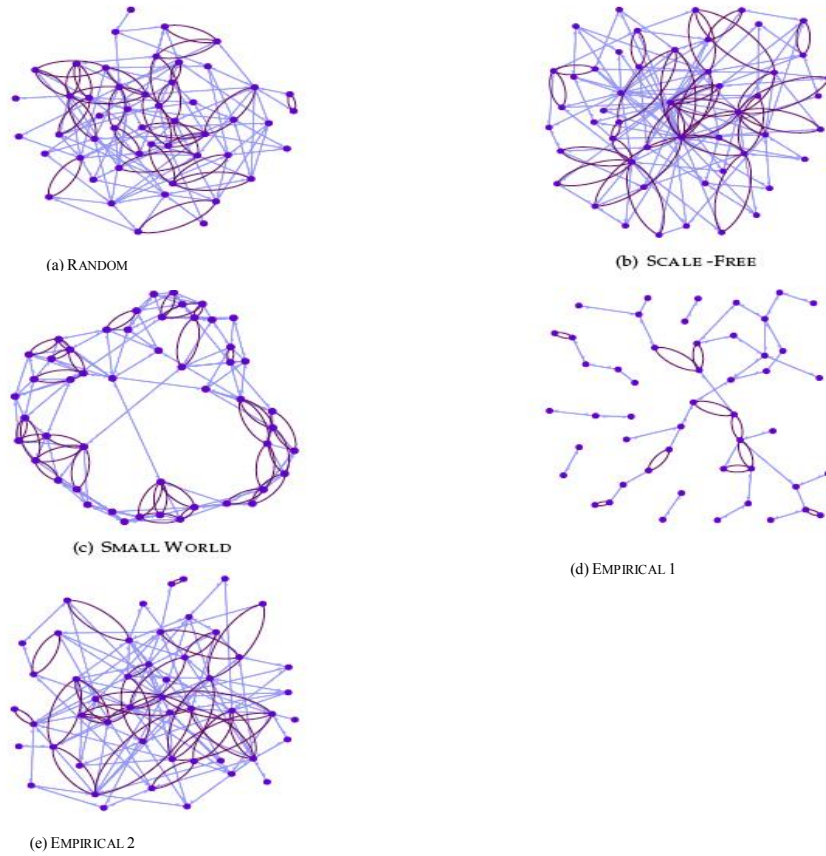

Figure 1. Simulation of various initial architectures: random, scale-free, small world, empirical (1 and 2)

## 2.2. Social contagion

We have modeled the social contagion mechanisms through which the disease can propagate from individuals to individuals or from environmental sources over populations, individuals changing of state like in biological regulatory networks for which many theoretical and numerical tools have been recently developed [13-16].

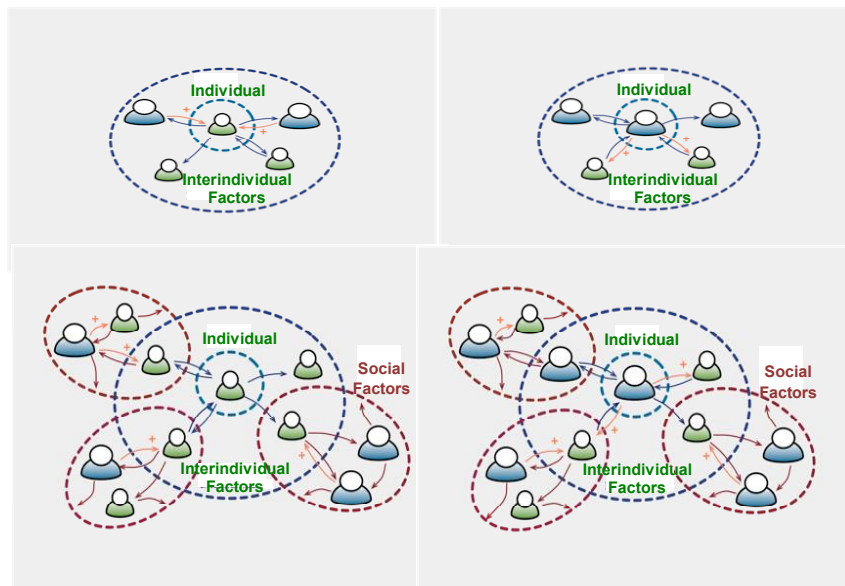

Figure 2. Inter-individual relationships between obese and non obese individuals in a social context

On Figure 2, each individual is represented in its social neighborhood: he can influence (orange and red arrows) the narrow context to which he belongs. Hence, each individual in a given social sub-network will receive direct influences from his neighbors (inter-individual factors) as well as influences from his environment (social factors) depending on his own context. Under these influences, some individual (in blue on Figure 2) can become obese and other not (in green on Figure 2).

### 3 Obesity dynamics of links and states

#### 3.1. Homophilic graphs

The function homophily (resp. heterophily) will be defined as the tendency of an individual to create (resp. cancel) links with other individuals sharing similar (resp. dissimilar) attributes, by playing with probability agents involved in an infectious contact having a given state (*e.g.*, for obesity, susceptible  $S$ , overweight  $W$  and obese  $O$ ) before contact. The tendency an agent or node  $i$  has to create or cut a link with another agent  $j$  in a social contagion graph  $G$  having  $N$  agents, depends on similarity distances  $d(i,j)$  in the graph. Let us suppose that there are two possible states  $x$  and  $y$  for the nodes of  $G$  and denote at time  $t$  by  $L_{x,y}(t)$  (resp.  $L_{x,x}(t)$ ) the number of heterophilic (resp. homophilic) links of type  $x$ ,  $L_x(t)$  the number of links coming from type  $x$  nodes and  $L(t)$  the total number of links, and by  $\tau$  the relaxation time. We suppose in each time lapse of duration  $\tau$ , a certain proportion of nodes (agents) creates (resp. cancel) links toward nodes being in same (resp. different) state, with a certain tolerance threshold. Then the simulation follows the successive steps:

1. At  $t = t_0$ , generate the random value  $\tau$  from an exponential distribution of parameter  $1/\beta$
2. At  $t = t_0 + \tau$ ,
  - choose a fraction  $\phi$  of nodes in  $G$ . Let  $M = \phi N$ .
  - for each node  $i$  of these  $M$  nodes ( $i=1, \dots, M$ ), define its state  $x(i)$  (known initial conditions), its out-degree  $k_i \in \mathbb{N}$  (equal to the number of links exiting from  $i$ ), generate its tolerance to the difference, a real number  $h_i$ ,  $0 \leq h_i \leq 1$ , from a probability distribution  $g(h)$  and do the following operations:
    - for  $k_i = 0$ , connection from  $i$  to  $j$ :
      - choose a node  $j$  by chance among  $N-1$  other nodes
      - create a link from  $i$  to  $j$  with probability  $h_i^{d(i,j)}$ , where  $d(i,j)$  is the direct distance between  $i$  and  $j$ , with 3 levels: 0, 1 and 2, defined as follows:
$$d(i,j)=0, \text{ if } x(i) = x(j)$$

$$=1, \text{ if } x(i)=S, x(j)=W \text{ and vice versa}$$

$$=1, \text{ if } x(i)=W, x(j)=O \text{ and vice versa}$$

$$=2, \text{ if } x(i)=S, x(j)=O \text{ and vice versa}$$
    - for  $k_i \geq 1$ , connection or disconnection from  $i$  to  $j$ :
      - if  $V_i$  denotes the set of neighbours of  $i$ , let choose a node  $j$  among the  $|V_i|=k_i$  neighbours of  $i$  with the probability  $1/k_i$ . We will denote by  $V_j^i$  the set of the neighbours of  $j$ , minus  $i$
      - let  $\delta(i,j)$  be the total similarity distance between nodes  $i$  and  $j$ . The link between  $i$  and  $j$  will be cut with the probability  $1-h_i^{\delta(i,j)}$ , where the total distance  $\delta$  is defined by:
$$\delta(i,j) = d(i,j), \text{ if } c(i,j) = 0$$

$$= \alpha d(i,j) + (1-\alpha)c(i,j), \text{ if } c(i,j) \neq 0,$$
where the indirect distance  $c(i,j) = \sum_{k \in V_j^i} d(i,k)/(k_j-1)$   

$$= 0, \text{ if } k_j=1$$
      - if the link between  $i$  and  $j$  has been cut, we choose by chance a new node  $k$  in  $G \setminus V_i \setminus V_j^i$  and we create a link from  $i$  to  $k$  with the probability:
$$\text{Prob}(i \rightarrow k) = f(d(i,k))n_{x(k)}h_i^{d(i,k)} / [\sum_{l \in G \setminus V_i \setminus V_j^i} n_{x(l)}h_i^{d(i,l)}],$$
where  $n_{x(k)}$  is the number of nodes in  $G \setminus V_i \setminus V_j^i$  having the same state as  $k$ , *i.e.*,  $n_{x(k)} = n_S$  (resp.  $n_W, n_O$ ) if  $k$  is susceptible (resp. overweight, obese). We will consider in the simulations 3 versions for the function  $f$ :
        - Version 1:  $f(d(i,w))=1$ , if  $d(i,w)=0$ ;  $=0$  elsewhere
        - Version 2:  $f(d(i,w))=1$ , if  $d(i,w)=0$  or  $1$ ;  $=0$  elsewhere
        - Version 3:  $f(d(i,w))=1$ , if  $d(i,w)=0, 1$  or  $2$ ,

- these versions being used in the individual centred network for representing three types of progressively increasing influence: exogenous heterogeneous (individual-cultural, Version 1), exogenous homogeneous (individual-social, Version 2), endogenous (individual-individual, Version 3)
3. Change the states  $x(j)$ , for all  $j$  at the end of links created, by increasing their obesity weight of one level ( $S$  to  $W$ ,  $W$  to  $O$ ,  $O$  to  $O$ )
  4. Generate a new  $\tau$  and go to 2
  5. Stop when the graph  $G$  is no more changing.

### 3.2. Homophilic dynamics simulations

On Figure 2, we have fixed the corporal states (obese, overweight and normal) following the distribution of the BMI in the French population [11] in 2009: obese (14,5%), overweight (31.9%) and normal (53,6%) individuals. The tolerance has been taken at the level 0.25 and the connection probability has been chosen following the Version 1. Directed networks with 1000 nodes each have been simulated, with a probability to have forward directional (resp. bidirectional) links equal to  $a=0.6$  (resp.  $b=0.2$ ). The node positioning has been done following the attraction-repulsion Fruchterman-Reingold algorithm [12].

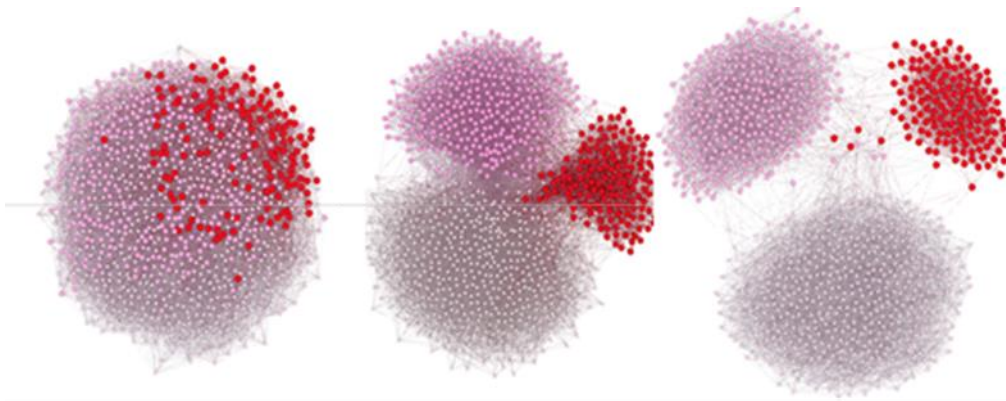

Figure 3. Dynamics with a progressive clustering (from left to right) inside a small-world directed network with initial proportion of obese individuals in red (14,5%), overweight in pink (31.9%), and normal in white (53,6%), with 0.25 tolerance and connection probability of the Version 1

### 3.3. Equilibrium configurations

Under the homophilic rule, the networks are converging until an equilibrium configuration of both links of the undirected graph architecture and node states, independently of the initial architecture and initial state distribution. By using a simulation engine of the social network, we can study the speed of convergence to this equilibrium for all the initial topologies proposed in Section 2. The Figure 4 shows that the relaxation time to the steady state (related to the speed of convergence to equilibrium) depends on the network topology. The shape of the initial and final “in-degree” distributions are about the same after applying the homophilic dynamics (Figures 4 and 5), but we can show that paradoxically in the small-world initial topology, the mean clustering coefficient diminishes, but the marginal clustering coefficient  $C_s$ , calculated for each state  $s$  increases (this phenomenon being due to the modification of the state distribution):  $C_s = \langle X_s \rangle / N$ , where  $\langle X_s \rangle$  is the expectation of the random variable equal to the number of nodes in state  $s$  linked to a node in the same state  $s$ . The global clustering coefficient  $C$  is defined by:  $C = \langle X \rangle / N$ , where  $\langle X \rangle$  is the expectation of the random variable equal to the number of couples of linked nodes having the same state. The final value of the homophily depends weakly on the topology (Figure 6). The final configuration of the network has always the homophily maximum, the segregation into 3 groups depending on the topology (Figures 6 and 7).

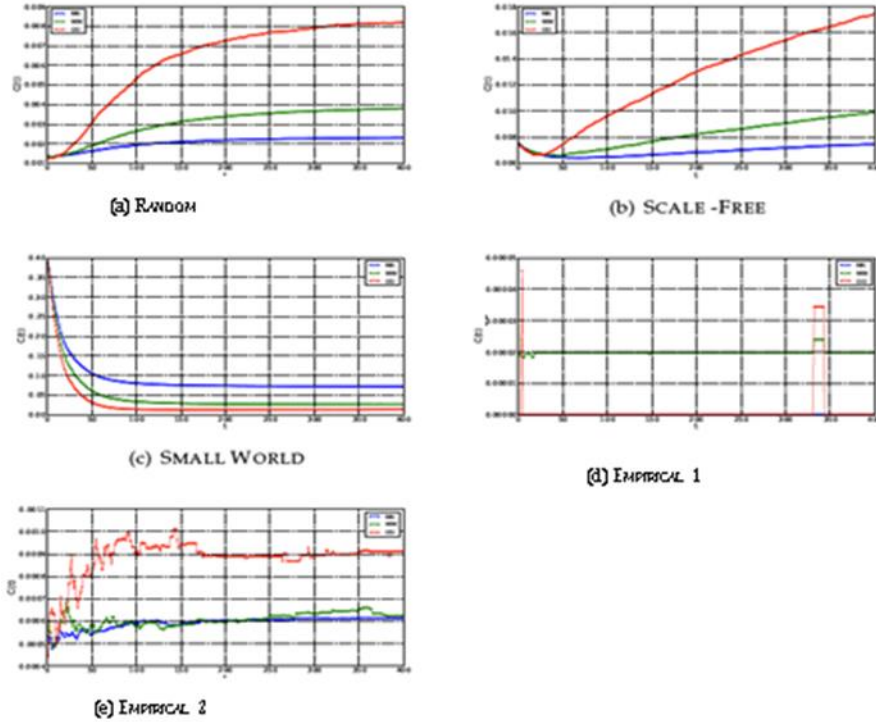

Figure 4. Evolution of the marginal clustering coefficient  $C_s$  for each state  $s$  and for the architectures and initial distribution of states (normal in blue, overweight in green and obese in red) of Section 2, with tolerance  $h$  equal to 0.25 and connection probability of the Version 3

In order to improve this study, a theoretical estimation of the speed of convergence to the equilibrium configuration could be made, as well as the consideration of the robustness of the process: do exist more than one equilibrium state, and if yes, are other “attractors” only fixed states or possibly periodic configurations? Which network parameters are critical, *i.e.*, at which parameter perturbation (provoking a change in number or nature of attractors) is sensitive the dynamics? Which perturbation of the initial configuration of the social network changes attraction (stability) basins? All these problems will be addressed in a future work.

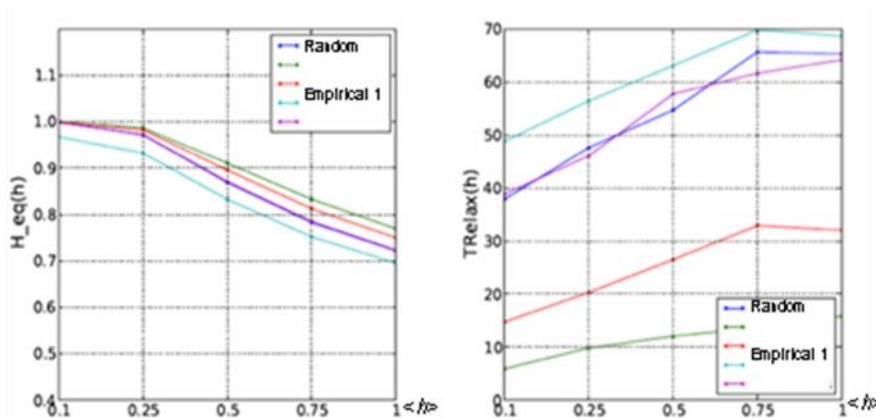

Figure 5. Left: with connection probability of the Version 3, evolution of the global connectivity  $C$  coefficient at equilibrium as function of the mean tolerance  $\langle h \rangle$ . Right: evolution of the relaxation time to equilibrium as function of the mean tolerance  $\langle h \rangle$

### 3.4. Examples of dynamics of obesity

Homophily defined as above suggests that individuals tend to interact with those who resemble them in terms of alimentary behaviour and the structure of the social fabric is involved in the increase and current development of obesity [17-29].

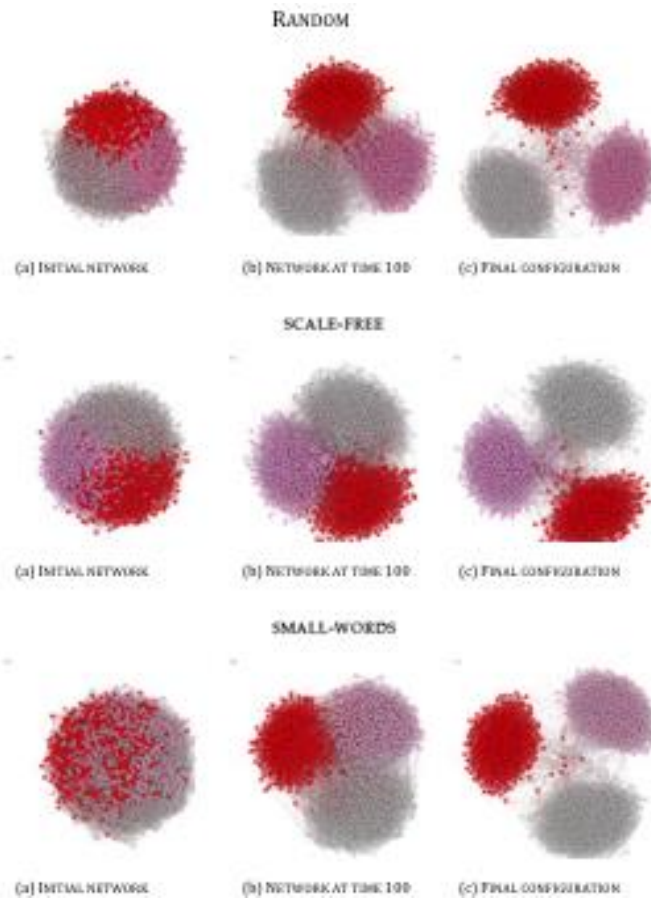

Figure 6. Homophilic dynamics for the architectures and initial distributions of states of Figure 5, with tolerance  $t$  equal to 0.25 and connection probability of Version 3

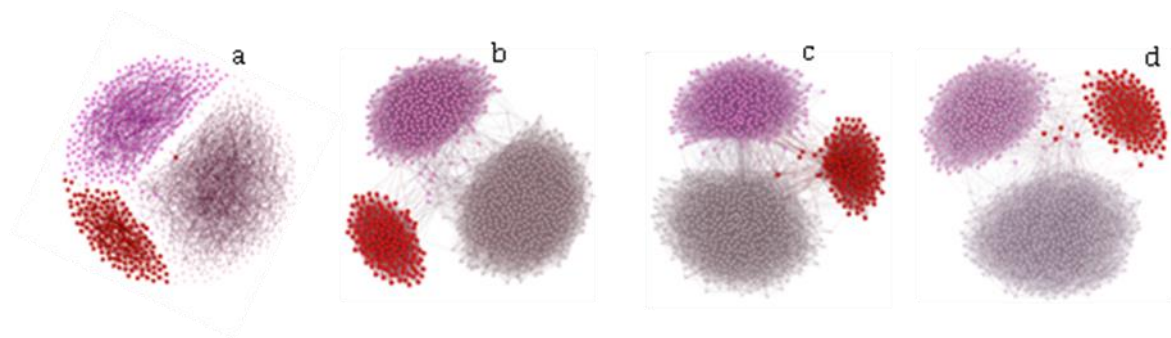

Figure 7. Simulation of social graphs representing obesity network: initial conditions (a), asymptotic state in case of an homophilic graph Version 1 (b), random graph (c), scale free graph (d) and small world graph (e)

By using the simulation rules of Section 3.1., we compare the simulated graphs with real data in case of obesity. Four situations have been tested: the pure random graph (links chosen by chance), the free scale graph (the distribution of out-degrees follows a power law), the small world graph (links around hub nodes are reinforced) and homophilic graphs, with different versions of probability of linking. The approach described above has highlighted the necessity to integrate a random dynamics at each scale to better understand the evolution of the obesity pathology, *e.g.*, in Figure 7, the

connectivity of the real social network representing the obesity spread is better taken into account in the homophilic network Version 1 (the qualitative differences between versions being small) than in the other versions: random, scale-free or small world ones.

## 4 Demographic dynamics

For evaluating the number of susceptible and to define them by age and sex (which are important factors in the occurrence of obesity), we need to develop a dynamic projection model by using key socio-demographic indicators of the studied population. The lack of comprehensive and documented data often not allows to use performant international tools of Individual Based Model (IBM) demographic simulation as FELICIE, DESTINIE, OMPHALE, MOGDEN, LIFEPATH,... [17-19]. So we proposed the model DOPAMID which requires less raw data for its dynamic projection method.

### 4.1. DOPAMID model overview

The objective of the model is to make evolve a population in function of statistics based on its composition in age classes. This evolution allows to express patterns in the composition of the population. Statistics used are the distribution of the population according to the age and sex of the individuals, mortality, fertility, composition of families as well as the dependency of individuals. Starting from a population respecting these statistics, the model advances in time over a period of up to 90 years. The members of this population will therefore age, reproduce, come dependent, die...

### 4.2. The model algorithm

The decision taking is based on the generation of random numbers. For example, for sex at birth, statistics are: 51,35 % of males and 48,65 % of females. A random number between 0 and 1 is generated, and if it is less than 0,5135, the child will be a boy and a girl, if it exceeds.

The initial number of human beings is supposed to be equal to 10,000. Each year and for each person, the scenario described in Figure 10 is applied.

We have for example simulated the evolution of the Iranian population between 2009 and 2050 (cf. Figure 8), for validating our model from real data and simulated projections coming from the US Bureau of Census [20]. A study of an important pathology associated to obesity, the type 2 diabetes [21], shows that the proportion of diabetic is equal to 3.5% in normal weight Iranian population, and 6.4% and 14.3% respectively in overweight and obese population, representing an Odd ratio of respectively 1.7 (the 95%-confidence interval being equal to [1.1, 2.5]) and 4 (the 95%-confidence interval being equal to [2.7, 5.8]). The demographic modelling allows calculating for each age class the proportion of obese and the risk of type 2 diabetes: here for example, the Odd ratio per 10 years is equal to 1.2 (the 95%-confidence interval being equal to [1.1-1.4]). A precise distribution with respect to gender and age class can be found in [22].

The connection between the demographic dynamics and the social networks has to be carefully made in the future: it needs a deep knowledge (presently absent) on the structure by age class into the social networks, as well as on the rules of transmission and intergenerational inheritance of the alimentation and adapted physical activity habits. Nevertheless, the evolution of the size of the whole population has to be already introduced in order to fix the number of nodes and interaction links for calibrating our social networks models.



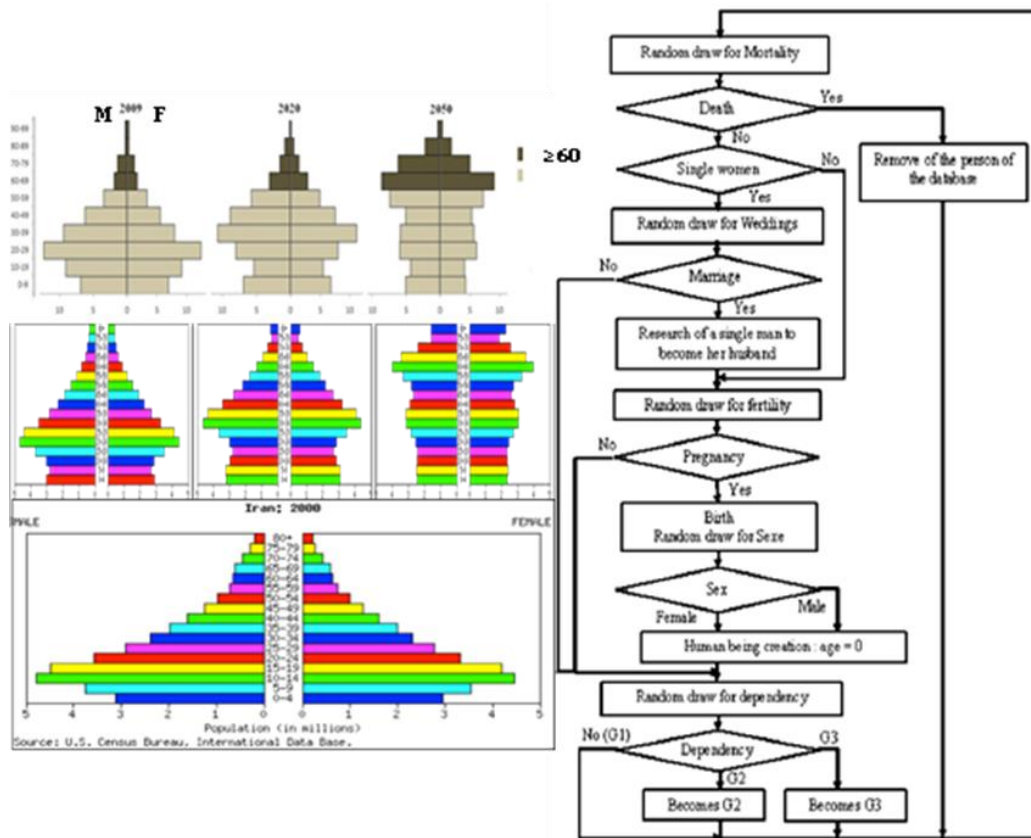

Figure 8. Left: top: simulation made by our DOPAMID model of the evolution of Iranian demography between 2009 and 2050, middle: same simulation by using the simulation algorithm of the US Census Bureau, bottom: real data in 2000. Right: ageing algorithm applied each year for each human being (<http://www.census.gov/population/international/>)

## 5 Towards the proposal of an obesity preventive policy

The BMI has been defined about two centuries ago by a Belgian physician (A. Quételet) and it represents the basic tool for doing the obesity diagnosis and therapeutic surveillance. New policies are now needed to contain this world pandemic and we suggest the following ways in order to watch and cure the obesity:

- 1) defining new optimal threshold for defining obesity states and associated risks from the classical BMI [23]
- 2) using a new index called the Body Adiposity Index (DAI) allowing differentiating muscular, skeletal and adipose masses [24]
- 3) elucidating all genetic factors involved in the obesity genesis (endogenous individual factors) [25]
- 4) searching for all metabolic factors implied in the development of the disease (nutrition, as well as predisposition to use glycolytic pathway more than oxidative phosphorylation in order to produce energy, like in the Warburg effect [26,27])
- 5) identifying all social factors favouring the present epidemic in particular exogenous environmental factors, in social networks involving young individuals (educative, sportive, familial, social,...) in order to prevent actively the disease before the adult age (for example, cf. [www.repop.fr](http://www.repop.fr)) at school or during the hospital sojourns [28]
- 6) studying all psycho-social factors leading to obesity stigmatization in relation to mental body image and self-esteem [29].

## 6 The dynamics of contacts

### 6.1. Influence of the contact duration

Let introduce now a contact duration  $\tau$  and a contagion coefficient  $\beta$  possibly depending on  $\tau$  [30]. It is possible to retrieve the quadratic term of interaction already present in all the classical models of contagion [30-40] by using a stochastic approach coming from the random chemistry of contacts [41-57] for interpreting the rules of Section 3.1. developed in [58]. We have, if the demographic dynamics is neglected as well as the overweight transition:

$$P(S(t+dt)=k, O(t+dt)=N-k) - P(S(t)=k, O(t)=N-k) = -\beta k(N-k)dt \int_0^T P(S(t-\tau)=k, O(t-\tau)=N-k)d\tau \\ + \beta(k+1)(N-k-1)dt \int_0^T P(S(t-\tau)=k+1, O(t-\tau)=N-k-1)d\tau,$$

where  $S(t)$  (resp.  $O(t)$ ) is the size of the susceptible (resp. obese) population at time  $t$ .

The microscopic equation above leads to the mean differential equation ruling the expectations of the random variables  $S$  and  $I$ :

$$dE(S(t))/dt = -\beta \int_0^T E(S(t-\tau))E(I(t-\tau))d\tau$$

and to the macroscopic equation:  $dS/dt = -\beta \int_0^T S(t-\tau)I(t-\tau)d\tau$ , in which we found the quadratic term of the classical models of contagion. This quadratic term is also present in the interaction potential of Hopfield like networks in which the study of the robustness with respect to the contagion parameter change has been performed [59-69] as well as in recent studies taking into account the spatial character of the disease spread [70-79].

### 6.2. Confinement and Saturation

The localisation of contamination has been treated by different authors [80, 81]. When contagion occurs in confined locations (like professional, educational or residence buildings), we can use saturation dynamics terms coming from the enzymatic kinetics (cf. for example [82, 83]) for expressing all the possibilities to have together  $k$  from the  $S$  susceptible population and  $i$  from the  $O$  obese population in  $n$  contagion sites located in  $B$  buildings. We call this quantity the partition function  $P(S, O)$  and  $B(\partial^2 \text{Log} P / \partial \text{Log} S \partial \text{Log} O) / n$  is the total mean number of occupied sites, considered as proportional to the infection rate, and we have:

$$dS(t)/dt = -\beta B(\partial^2 \text{Log} P / \partial \text{Log} S \partial \text{Log} O) / n + fS - \mu S + \rho O \\ dO(t)/dt = \beta B(\partial^2 \text{Log} P / \partial \text{Log} S \partial \text{Log} O) / n + f'O - \mu'O - \rho O,$$

where the demographic parameters  $f$  (fecundity) and  $\mu$  (mortality) are taken into account for the susceptible as well as for the obese population ( $f'$  and  $\mu'$ ) and where  $\rho$  denotes the recovering rate at which an obese recovers an healthy weight.

An example of such a dynamics is the saturation Michaëlian one, if there is only one contagion site:

$$P(S, O) = (1 + v_{C,S}S)(1 + v_{C,O}O),$$

where  $v_{C,S}$  (resp.  $v_{C,O}$ ) is the probability for a susceptible (resp. obese) to access a contagion site. If  $v_{C,S} = 1$  and  $v_{C,O} \ll 1$ , then the infection rate equals about  $\beta SO / (1+S)$  and the equations of the dynamics are:

$$dS(t) = -\beta S(t)O(t)/(1+S(t)) + (f - \mu + \rho)S(t) \\ dO(t) = \beta S(t)O(t)/(1+S(t)) + (f' - \mu' - \rho)O(t)$$

### 6.3 Non-linear interactions and complex dynamics

Threshold interactions used in classical Hopfield like models [59-69] are already non-linear ones, but take into account only pair contacts, neglecting possible additional effects due to the presence and mutual interaction of more than two individuals in the contagion process. It is now possible to

introduce for modelling this possible potentialization a formalism for being able to define non-linear  $n$ -uples interactions [84] and simulate the model in a spatial Markovian context like in the present study or in certain case of remote spatial influence (due to the new social networking on the web) in a renewal context [85], as well different time scales modelling complex dynamics, for separating the local dynamics from the global trend of the obesity epidemic [86].

## 7 Conclusion

Results shown in this paper about social networks involved in obesity have been obtained by modeling and simulating networks with various initial architecture (random, scale-free, small-world, empirical) evolving under the so-called social homophilic constraint. The computed evolution of these networks seems to be similar to the real one observed in developed countries for a socially “contagious” disease, the obesity. Complementary studies are now required allowing from large samples estimating the unobservable parameters linked both to initial network architecture (taking into account the specificity of the sub-populations of susceptibles, *e.g.*, differences between the schoolchildren, professional and elderly people networks) and to their weights evolution, as well as incorporating the demographic dynamics [87], a more accurate model of social contacts through which the disease can spread out and some elements about the psychogenesis of the homophilic dynamics [88-90].

## References

- [1] A. Myers, J.C. Rosen, Obesity stigmatization and coping: relation to mental health symptoms, body image, and self-esteem, *Int. J. Obesity Relat. Metab. Disord.* 23 (1999) 221–230.
- [2] H. Tunstall-Pedoe, MONICA Project. World's largest study of heart disease, stroke, risk factors, and population trends 1979-2002", WHO, 2003.
- [3] International Association for the Study of Obesity Obesity: preventing and managing the global epidemic. International Obesity Task Force Prevalence Data, WHO TRS 894, 2000.
- [4] G. Maillard, M.A. Charles, N. Thibault, A. Forhan, C. Sermet, A. Basdevant, E. Eschwege, Trends in the prevalence of obesity in the french adult population between 1980 and 1991, *Int. J. Obesity Relat. Metab. Disord.* 23 (1999) 389-394.
- [5] J. Barth, What should we do about the obesity epidemic?, *Practical Diabetes International*, 19 (2002) 119-122.
- [6] T. de Saint-Pol, Obésité et milieux sociaux en France : les inégalités augmentent, *Bulletin Epidemiologique Hebdomadaire* 20 (2008) 175-179.
- [7] J. Laitinen, C. Power, M.R Jarvelin, Family social class, maternal body mass index, childhood body mass index, and age at menarche as predictors of adult obesity, *American Journal of Clinical Nutrition* 74 (2001) 287-294.
- [8] M. Scharoun-Lee, L.S. Adair, J.S. Kaufman, P.Gordon-Larsen, Obesity, race/ethnicity and the multiple dimensions of socio-economic status during the transition to adulthood: A factor analysis approach, *Social Science and Medicine* 6 (2009) 708-716.
- [9] N. Christakis, J. Fowler, The spread of obesity in a large social network over 32 years, *The New England Journal of Medicine* 17 (2006) 77-82.
- [10] E. Cohen-Cole, J.M. Fletcher, Is obesity contagious? Social networks vs. environmental factors in the obesity epidemic, *Journal of Health Economics* 27 (2008) 1382-1387.
- [11] ObEpi-Roche, Enquête épidémiologique nationale sur le surpoids et l'obésité, Roche, Paris, 2009.
- [12] T. Fruchterman, E. Reingold, Graph drawing by force-directed placement, *Software: Practice and Experience* 21 (1991) 1129–1164.
- [13] J. Demongeot, H. Ben Amor, A. Elena, P. Gillois, M. Noual, S. Sené, Robustness of regulatory networks. A generic approach with applications at different levels: physiologic, metabolic and genetic, *International Journal of Molecular Sciences* 10 (2009) 4437–4473.
- [14] J. Demongeot, A. Elena, M. Noual, S. Sené, F. Thuderoz, «Immunetworks», intersecting circuits and dynamics, *Journal of Theoretical Biology* 280 (2011) 19-33.
- [15] J. Demongeot, E. Goles, M. Morvan, M. Noual, S. Sené, Attraction basins as gauges of environmental robustness in biological complex systems, *PLoS ONE* 5 (2010) 8.
- [16] J. Demongeot, M. Noual, S. Sené, Combinatorics of Boolean automata circuits dynamics, *Discrete Applied Mathematics*, 160 (2012) 398-415.

- [17] J. Gaymu, P. Festy, M. Poulain, G. Beets, From elderly population projections to policy implications, in: Future elderly living conditions in Europe (Felicie), Les cahiers de l'INED 162, INED, Paris, 2008, 267-290.
- [18] M. Duée, C. Rebillard, La dépendance des personnes âgées: une projection en 2040, Données sociales - La société française, INSEE, Paris, 2006.
- [19] J. Légaré, Y. Décarie, Using Statistics Canada LifePaths Microsimulation Model to Project the Health Status of Canadian Elderly, SEDAP Research Paper 227, SEDAP, Hamilton, 2008.
- [20] <http://www.census.gov/population/international/>
- [21] H. Harati, F. Hadaegh, N. Saadat, F. Azizi, Population-based incidence of Type 2 diabetes and its associated risk factors: results from a six-year cohort study in Iran, BMC Public Health 9 (2009) 186.
- [22] F. Hosseinpanah, M. Barzin, P.S. Eskandary, P. Mirmiran, F. Azizi, Trends of obesity and abdominal obesity in Tehranian adults: a cohort study, BMC Public Health 9 (2009) 426.
- [23] V. Dauphinot, H. Wolff, F. Naudin, R. Gueguen, C. Sermet, J.M. Gaspoz, M.P. Kossovsky, New obesity body mass index threshold for self-reported data, J. Epidemiology Com. Health 63 (2009) 128-132.
- [24] R.N., Bergman, D. Stefanovski, T.A. Buchanan, A.E. Sumner, J.C. Reynolds, N.C. Sebring, A.H. Xiang, R.M. Watanabe, A Better Index of Body Adiposity, Obesity 19 (2011) 1083-1089.
- [25] A. Baranova, R. Collantes, S.J. Gowder, H. Elariny, K. Schlauch, A. Younoszai, S. King, M. Randhawa, S. Pusulury, T. Alsheddi, J.P. Ong, L.M. Martin, V. Chandhoke, Z.M. Zobair, M.D. Younossi, Obesity-related Differential Gene Expression in the Visceral Adipose Tissue, Obesity Surgery, 15 (2005) 758-765.
- [26] L. Demetrius, J. Coy, J. Tuszynski, Cancer proliferation and therapy: the Warburg effect and quantum metabolism, Theoretical Biology and Medical Modelling 7 (2010) 2.
- [27] L. Demetrius, J. Tuszynski, Quantum metabolism explains the allometric scaling of metabolic rates, J. Royal Soc. Interface 7 (2010) 507-514.
- [28] C. Delhumeau, J. Demongeot, F. Langlois, C. Taramasco, Modelling the hospital length of stay in Diagnosis Related Groups Data Bases, in: IEEE ARES-CISIS' 09 & BT' 09, IEEE Press, Piscataway, 955-960, 2009.
- [29] A. Myers, J.C. Rosen, Obesity stigmatization and coping: relation to mental health symptoms, body image, and self-esteem, Int. J. Obes. Relat. Metab. Disord. 23 (1999) 221-230.
- [30] J. Demongeot, O. Hansen, H. Hessami, A.S. Jannot, J. Mintsá, M. Rachdi, C. Taramasco, Random modelling of contagious diseases, Acta Biotheoretica (Accepted).
- [31] D. Bernoulli, Essai d'une nouvelle analyse de la mortalité causée par la petite vérole, et des avantages de l'inoculation pour la prévenir, Mém. Acad. Roy. Sci., Paris, 1760.
- [32] J. d'Alembert, Onzième Mémoire : sur l'application du calcul des probabilités à l'inoculation de la petite vérole ; notes sur le mémoire précédent ; théorie mathématique de l'inoculation, in: Opuscles mathématiques, David, Paris, 1761, 26-95.
- [33] W.H. Hamer, The Milroy lectures on epidemic disease in England: the evidence of variability and persistency of type, Bedford Press, London, 1906, 733-739.
- [34] R. Ross, Prevention of Malaria, John Murray, London, 1910.
- [35] J. Brownlee, On the Curve of the Epidemic, The British Medical Journal 1 (1915) 799-800.
- [36] R. Ross, Some a priori pathometric equations, The British Medical Journal 1 (1915) 546-547.
- [37] R. Ross, An Application of the Theory of Probabilities to the Study of a priori Pathometry. Part I, Proceedings Royal Soc. London Series A 92 (1916) 204-230.
- [38] M.E. Gibson, Sir Ronald Ross and his contemporaries, J. Royal Society of Medicine 71 (1978) 611-618
- [39] W.O. Kermack, A.G. McKendrick, A contribution to the mathematical theory of epidemics, Proceedings Royal Soc. London, Series A 115 (1927) 700-721.
- [40] W.O. Kermack, A.G. McKendrick, Contributions to the mathematical theory of epidemics. III. Further studies of the problem of endemicity, Proceedings Royal Soc. London Series A 121 (1933) 141-194.
- [41] M. Delbrück, Statistical fluctuations in autocatalytic reactions, J. Chem. Phys. 8 (1940) 120-124.
- [42] A.F. Bartholomay, On the Linear Birth and Death Processes of Biology as Markoff Chains, The Bulletin of Mathematical Biophysics 20 (1958) 97-118.
- [43] A.F. Bartholomay, Stochastic models for chemical reactions: I. Theory of the unimolecular reaction process, Bull. Math. Biophys. 20 (1958) 175-190.
- [44] A.F. Bartholomay, Stochastic models for chemical reactions: II. The unimolecular rate constant, Bull. Math. Biophys. 21 (1959) 363-373.
- [45] D.A. McQuarrie, Kinetics of small systems, J. Chem. Phys. 38 (1963) 433-436.
- [46] D.A. McQuarrie, C.J. Jachimowski, M.E. Russell, Kinetics of small systems. II, J. Chem. Phys. 40 (1964) 2914-2921.
- [47] C.J. Jachimowski, D.A. McQuarrie, M.E. Russell, A Stochastic Approach to Enzyme-Substrate Reactions, Biochemistry 3 (1964) 1732-1736.
- [48] D.A. McQuarrie, Stochastic approach to chemical kinetics, J. Appl. Probab. 4 (1967) 413-478.

- [49] M.R. Hoare, Molecular Markov Processes, *Nature* 226 (1970) 599-603.
- [50] N.T.J. Bailey, The simple stochastic epidemic: A complete solution in terms of known functions, *Biometrika* 50 (1963) 235-240.
- [51] K. Dietz, Epidemics and Rumours: A Survey, *Journal of the Royal Statistical Society. Series A (General)* 130 (1967) 505-528.
- [52] J. Demongeot, A stochastic model for the cellular metabolism, in: *Recent Development in Stats*, North Holland, Amsterdam, 1977, 655-662.
- [53] L. Allen, An Introduction to Stochastic *Epidemic* Models, *Mathematical Epidemiology* 1945 (2008) 81-130.
- [54] C.J. Rhodes, L. Demetrius, Evolutionary Entropy Determines Invasion Success in Emergent Epidemics, *PLoS ONE* 5 (2010) e12951.
- [55] T. Britton, Stochastic epidemic models: a Survey, *Mathematical Biosciences* 225 (2010) 24-35.
- [56] D.T. Gillespie, A General Method for Numerically Simulating the Stochastic Time Evolution of Coupled Chemical Reactions, *Journal of Computational Physics* 22 (1970) 403-434.
- [57] P. Magal, S. Ruan, Susceptible-Infectious-Recovered Models Revisited: From the Individual Level to the Population Level, *Bulletin of Mathematical Biology* (Submitted).
- [58] C. Taramasco, Impact de l'obésité sur les structures sociales et impact des structures sociales sur l'obésité ? Facteurs individuels et environnementaux, PhD thesis, Ecole Polytechnique, Paris, 2011.
- [59] M. Aldana, P. Cluzel, A natural class of robust networks, *Proc. Natl. Acad. Sci. USA* 100 (2003) 8710-8714.
- [60] J. Demongeot, A. Elena, S. Sené, Robustness in neural and genetic networks, *Acta Biotheoretica* 56 (2008) 27-49.
- [61] H. Ben Amor, J. Demongeot, A. Elena, S. Sené, Structural Sensitivity of Neural and Genetic Networks, *Lecture Notes in Computer Science* 5317 (2008) 973-986.
- [62] A. Elena, J. Demongeot, Interaction motifs in regulatory networks and structural robustness, in: *IEEE ARES-CISIS' 08*, IEEE Press, Piscataway, 2008, 682-686.
- [63] A. Elena, H. Ben-Amor, N. Glade, J. Demongeot, Motifs in regulatory networks and their structural robustness, in: *IEEE BIBE' 08*, IEEE Press, Piscataway, 2008, 234-242.
- [64] A. Elena, Robustesse des réseaux d'automates à seuil, University J. Fourier, Grenoble, 2009.
- [65] J. Demongeot, A. Elena, M. Noual, S. Sené, Random Boolean Networks and Attractors of their Intersecting Circuits, in: *Proceedings IEEE AINA' 11*, IEEE Proceedings, Piscataway, 2011, 483-487.
- [66] N. Glade, A. Elena, N. Fanchon, J. Demongeot, H. Ben Amor, Determination, optimization and taxonomy of regulatory networks. The example of *Arabidopsis thaliana* flower morphogenesis, in: *IEEE AINA' 11*, IEEE Press, Piscataway, 2011, 488-494.
- [67] J. Demongeot, J. Waku, Robustness in genetic regulatory networks, II Application to genetic threshold Boolean random regulatory networks (getBren), *Comptes Rendus Mathématique*, 350 (2012) 225-228.
- [68] J. Demongeot, J. Waku, Robustness in genetic regulatory networks, IV Application to genetic networks controlling the cell cycle, *Comptes Rendus Mathématique* 350 (2012) 293-298.
- [69] J. Demongeot, E. Drouet, A. Moreira, Y. Rechoum, S. Sené, Micro-RNAs: viral genome and robustness of the genes expression in host, *Phil. Trans. Royal Soc. A* 367 (2009) 4941-4965.
- [70] J.S. Koopman, I.M. Longini, The Ecological Effects of Individual Exposures and Nonlinear Disease Dynamics in Populations, *Am. J. Public Health* 84 (1994) 836-842.
- [71] M. Kretzschmar, Measures of concurrency in networks and the spread of infectious disease, *Mathematical Biosciences* 133 (1996) 165-195.
- [72] M.M. Sathik, A.A. Rasheed, Social Network Analysis in an Online Blogosphere, *International Journal of Engineering Science and Technology* 3 (2011) 117-121.
- [74] J. Gaudart, R. Giorgi, B. Poudiougou, S. Ranque, O. Doumbo, J. Demongeot, Spatial cluster detection: principle and application of different general methods, *Rev. Epid. Santé Pub.* 55 (2007) 297-306.
- [75] J. Gaudart, O. Touré, N. Dessay, A.L. Dicko, S. Ranque, L. Forest, J. Demongeot, O.K. Doumbo, Modelling malaria incidence with environmental dependency in a locality of Sudanese savannah area, *Mali. Malaria J.* 8, (2009) e61.
- [76] J. Gaudart, M. Ghassani, J. Mintsa, M. Rachdi, J. Waku, J. Demongeot, Demography and Diffusion in epidemics: Malaria and Black Death spread, *Acta Biotheoretica* 58 (2010) 277-305.
- [77] J. Demongeot, J. Gaudart, J. Mintsa, M. Rachdi, Demography in epidemics modelling, *Com. Pure & Appl. Analysis* 11 (2012) 61-82.
- [78] J. Demongeot, J. Gaudart, A. Lontos, E. Promayon, J. Mintsa, M. Rachdi, Least diffusion zones in morphogenesis and epidemiology, *Int. J. Bifurcation and Chaos* 22 (2012) 50028.
- [79] J. Demongeot, M. Ghassani, M. Rachdi, I. Ouassou, C. Taramasco, Archimedean Copula and Contagion Modelling in Epidemiology, *Networks & Heterogeneous Media* 8 (2013) 149-170.
- [80] P. Amarasekare, Interactions between local dynamics and dispersal: insights from single species models, *Theoretical Population Biology* 53 (1998) 44-59.

- [81] J.A.N. Filipe, G.J. Gibson, Comparing approximations to spatio-temporal models for Epidemics with local Spread. *Bull. Math. Biol.* 63 (2001)603-624
- [82] J. Demongeot, M. Laurent, Sigmoidicity in allosteric models. *Math. Biosciences* 67 (1983) 1-17.
- [83] J. Demongeot, N. Kellershohn, Glycolytic oscillations: an attempt to an "in vitro" reconstitution of the higher part of glycolysis. *Lectures Notes in Biomaths* 49 (1983) 17-31.
- [84] J. Demongeot, S. Sené, The singular power of the environment on nonlinear Hopfield networks, in: *CMSB'11, ACM Proceedings, New York, 2011*, 55-64.
- [85] J. Demongeot, J. Fricot, Random fields and renewal potentials, *NATO ASI Serie F* 20 (1986) 71–84.
- [86] M. Barthélemy, J.P. Nadal, H. Berestycki, Disentangling collective trends from local dynamics, *Proc. Natl. Acad. Sci. USA* 107 (2010) 7629–7634.
- [87] J. Demongeot, O. Hansen, H. Hessami, A.S. Jannot, J. Mintsá, M. Rachdi, C. Taramasco, Random modelling of contagious diseases. *Acta Biotheoretica* 61 (2013) 141-172.
- [88] B. Trojaola-Zapirain, F. Carminati, A. Gonzales Torres, E. Gonzales de Mendivil, C. Fouassier, M. Gex-Fabry, F. Martin, J. Labarere, J. Demongeot, E.N. Lorincz, G. Galli Carminati, Group unconscious common orientation: exploratory study in OMIE group training for therapists. *Neuroquantology* 12 (2014) 139-150.
- [89] S.A. Cunningham, E. Vaquera, C.C. Maturo, K.M. Venkat Narayan, Is there evidence that friends influence body weight? A systematic review of empirical research. *Social Science and Medicine* 75 (2012) 1175-1183.
- [90] W.A. Brechwald, M.J. Prinstein, Beyond homophily: a decade of advances in understanding peer influence processes. *Journal of Research on Adolescence* 21 (2011), 166e179

## Reinhart–Heinrich Doctoral Thesis Award



ESMTB announces the annual Reinhart Heinrich Doctoral Thesis Award to be presented to the student submitting the best doctoral thesis within the current year 2014 in any area of Mathematical and Theoretical Biology.

Professor Reinhart Heinrich (1946 – 2006) started his research career in theoretical physics and then moved into biochemistry, becoming a full professor and head of theoretical biophysics at the Humboldt University, Berlin in 1990. He is considered a father of the field that is now named Systems Biology, since he investigated various topics such as modelling metabolic networks and metabolic control theory, modelling of signal transduction networks, nonlinear dynamics as applied to biological systems, protein translocation, lipid translocation, vesicular transport, and even DNA repair. Reinhart Heinrich was always searching for the principles that underlie observations, looking for different perspectives and connecting theoretical abstraction with biological evidence. In this way, he inspired numerous students, gave them insight and direction for future research in modern mathematical and theoretical biology, and organized a large number of memorable conferences. Gratefully acknowledging his stimulating support of our interdisciplinary field and, in particular, his way of guiding students and young scientists, the Board of ESMTB decided to offer a Doctoral Thesis Award annually to commemorate Reinhart Heinrich and his legacy in mathematical and theoretical biology.

Prize Awarding Committee includes:

Carlos Braumann  
Andreas Deutsch  
Philip Maini  
David Rand  
Stefan Schuster (former assistant to Reinhart Heinrich)

### Award

A summary of the thesis receiving the award will be published as the lead article in the 2013 issue of the European Communications in Mathematical and Theoretical Biology. The *award* includes:

- *an invitation to present a lecture at the forthcoming triennial ESMTB Conference or, alternatively,*
- *a limited travel grant by ESMTB for a scientific visit of the recipient's own choice,*
- *1 year's free membership of ESMTB.*
- *A voucher for Springer books*

### Application

Potential applicants may be nominated by any ESMTB member. To nominate a person for the Reinhart Heinrich Doctoral Thesis Award, the following information should be submitted to Andreas Deutsch ([andreas.deutsch@tu-dresden.de](mailto:andreas.deutsch@tu-dresden.de)):

1. Name, address, phone number, affiliation, and email address of the **nominator**.
2. Name, address, phone number, affiliation, and email address of the **nominee**.
3. A detailed **statement** describing why the nominee should be considered for the award.
4. An **extended summary** of the thesis (ca. 2-5 pages plus eventual pictures).
5. A CV of the nominee in some form.

Closing date for nominations is *30th November 2014*, by which time the thesis should have received final acceptance by the institution granting the doctoral degree.

Shortlisted applicants will be asked to send their full thesis.

## CALL FOR MEMBERSHIP FEES 2014/15



<http://www.esmtb.org>

ESMTB membership includes free electronic subscription of the official journal of the Society  
***Journal of Mathematical Biology***  
and reduced low subscription rates to the **print edition** (25 Euro) as well as for several other journals.

Please register at [www.esmtb.org](http://www.esmtb.org) and send your payment of the required annual dues for 2014/15 by bank draft transfer or electronically (PayPal).

### Membership Fees per year:

The **Individual Annual Membership Fee** is:

- 50 Euro (full member)
- 40 Euro (ISTMB, JSMB, NVTB, SFBT, SMB full member)
- 25 Euro (student, developing country or Eastern European member)
- 20 Euro (student SMB member)

The **Institutional Annual Membership Fee** is:

200 Euro

### c. The Life Membership Fee is:

10. 750 EUR (age 40 or above)
11. 500 EUR (age 50 or above)
12. 250 EUR (age 60 or above)

### Details for bank draft transfer:

Bank: Commerzbank

Account Name: ESMTB

Account Number: 04 076 801 01

Bank Code No.: 850 800 00

SWIFT-BIC: DRES DD FF

IBAN: DE 18 85080000 0407680101

Bank Address:

Commerzbank, Dr.Külz-Ring 10

D-01067 Dresden, Germany

### Further information:

Prof. Dr. Andreas Deutsch, ESMTB treasurer

Center for Information Services and High Performance Computing

Dresden University of Technology

[Andreas.Deutsch@tu-dresden.de](mailto:Andreas.Deutsch@tu-dresden.de)



---

**ECMTB May 2014, No. 17: CONTENTS**

---

**LETTER FROM THE PRESIDENT ..... 1**  
**MINUTES OF THE ESMTB BOARD MEETING ..... 2**  
**EXTENDED ABSTRACT OF THE AWARDED THESIS ..... 5**  
**TOPICS IN MATHEMATICAL BIOLOGY ..... 11**  
**REINHART HEINRICH DOCTORAL THESIS AWARD 2014 ..... 29**